



Version: 1.0

Total pages: 26

Date: February 6, 2004

# AU OPTRONICS CORPORATION

## Product Specifications

### 10.4" SXGA Color TFT-LCD Module

**Model Name: G104SN03**

**V.0**

Approved by	Prepared by
<b>Martin Sun</b>	<b>Yen Chuang</b>

*AU Optronics Corporation*

Customer	Checked & Approved by
<b><i>All</i></b>	



**Version: 1.0**

**Total Pages: 26**

**Date: February 6, 2004**

**Product Functional Specification**

**10.4 inch SVGA Color TFT LCD Module**

**Model Name: G104SN03**

**V.0**

**(u ) Preliminary Specification**

**( ) Final Specification**

**Note: This Specification is subject to change without notice.**



# I. Contents

<b>1.0</b>	<b>Handling Precautions</b>	<b>5</b>
<b>2.0</b>	<b>General Description</b>	<b>6</b>
2.1	Display Characteristics	
2.2	Functional Block Diagram	
<b>3.0</b>	<b>Absolute Maximum Ratings</b>	<b>9</b>
<b>4.0</b>	<b>Optical Characteristics</b>	<b>10</b>
<b>5.0</b>	<b>Signal Interface</b>	<b>12</b>
5.1	Connectors	
5.2	Signal Pin	
5.3	Signal Description	
5.4	Signal Electrical Characteristics	
<b>6.0</b>	<b>Pixel Format Image</b>	<b>16</b>
<b>7.0</b>	<b>Power Consumption</b>	<b>17</b>
<b>8.0</b>	<b>Interface Timing</b>	<b>19</b>
8.1	Display Color v.s. Input Data Signal	
8.2	Input Signal Timing	
8.3	Display Position	
<b>9.0</b>	<b>Backlight Characteristics</b>	<b>23</b>
<b>10.0</b>	<b>Reliability Test Items</b>	<b>24</b>
<b>11.0</b>	<b>Display Quality</b>	<b>24</b>
<b>12.0</b>	<b>Packing Dimension</b>	<b>25</b>
<b>13.0</b>	<b>Mechanical Characteristic</b>	<b>26</b>



## II. Record of Revision

<b>Version and Date</b>	<b>Page</b>	<b>Old description</b>	<b>New Description</b>	<b>Remark</b>
1.0 Feb. 6, 2004	All	N/A	First Edition for Customers	



## 1.0 Handling Precautions

- 1) Since front polarizer is easily damaged, pay attention not to scratch it.
- 2) Be sure to turn off power supply when inserting or disconnection from input connector.
- 3) Wipe off water drop immediately. Long contact with water may cause discoloration or spots.
- 4) When the panel surface is soiled, wipe it with absorbent cotton or other soft cloth.
- 5) Since the panel is made of glass, it may break or crack if dropped or bumped on hard surface.
- 6) Since CMOS LSI is used in this module, take care of static electricity and insure human earth when handling.
- 7) Do not open nor modify the module Assembly.
- 8) Do not press the reflector sheet at the back of the module to any directions.
- 9) In case if a module has to be put back into the packing container slot after once it was taken out from the container, do not press the center of the CCFL Reflector edge. Instead, press at the far ends of the CFL Reflector edge softly. Otherwise the TFT module may be damaged.
- 10) At the insertion or removal of the Signal Interface Connector, be sure not to rotate nor tilt the interface Connector of the TFT module.
- 11) After installation of the TFT module into an enclosure, do not twist nor bend the TFT module even momentary. At designing the enclosure, it should be taken into consideration that no bending/twisting forces are applied to the TFT module from outside. Otherwise the TFT module may be damaged.
- 12) Cold cathode fluorescent lamp in LCD contains a small amount of mercury. Please follow local ordinances or regulations for disposal.
- 13) Small amount of materials having no flammability grade is used in the LCD module should be supplied by power complied with requirements of Limited Power Source, or be applied exemption.
- 14) The LCD module is designed so that the CFL in it is supplied by Limited Current Circuit. Do not connect the CFL in Hazardous Voltage Circuit.



## 2.0 General Description

This specification applies to the 10.4 inch color TFT LCD module G104SN03 V.0.

This module is designed for General Display.

The screen format is intended to support the SVGA (800(H) x 600(V)) screen and 262k colors (RGB 6-bits data driver).

All input signals are LVDS interface compatible.

The module does not contain an inverter card for backlight.

### Features

- SVGA 800(H) x600(V) resolution
- 1 CCFL(Cold cathode Fluorescent Lamp)
- High contrast ratio, High transmittance ratio
- Wide viewing angle
- High speed response
- Low power consumption
- LVDS interface

### Applications

Information Appliance

Industrial Application



## 2.1 Display Characteristics

The following items are characteristics summary on the table under 25°C condition :

Items	Unit	Specifications
Screen Diagonal	[inch]	10.4"
Outline dimension	[mm]	236.0(W) x 174.3(H) x 5.6(D)
Active Area	[mm]	211.2(H) x 158.4(V)
Resolution H x V		800(R, G,B x3) x 600
Pixel Pitch	[mm]	0.264(H) x 0.264(V)
Pixel Arrangement		R.G.B. Vertical Stripe
Display Mode		TN mode, Normally White
Typical White Luminance (ICFL=4.5 mA)	[cd/m <sup>2</sup> ]	230 Typ. (center)
Contrast Ratio		500 : 1 Typ.
Optical Rise Time/Fall Time	[msec]	10/25 Typ.
Viewing angle (CR ≥ 10)		60/60/35/65 (L/R/U/D)
Nominal Input Voltage VDD	[Volt]	+3.3 Typ.
Typical Power Consumption (VDD line + VCFL line)	[Watt]	3.3 Typ
Weight	[Grams]	280 Typ ± 10
Surface treatment		Anti-glare,hard coating 3H
Electrical Interface		1 channel LVDS
Support Color		Native 262K colors (RGB 6-bit driver)
Temperature Range		
Operating	[°C]	0 to +50
Storage(Shipping)	[°C]	-20 to +60



## 2.2 Functional Block Diagram

The following diagram shows the functional block of the 10.4 inches Color TFT LCD Module :

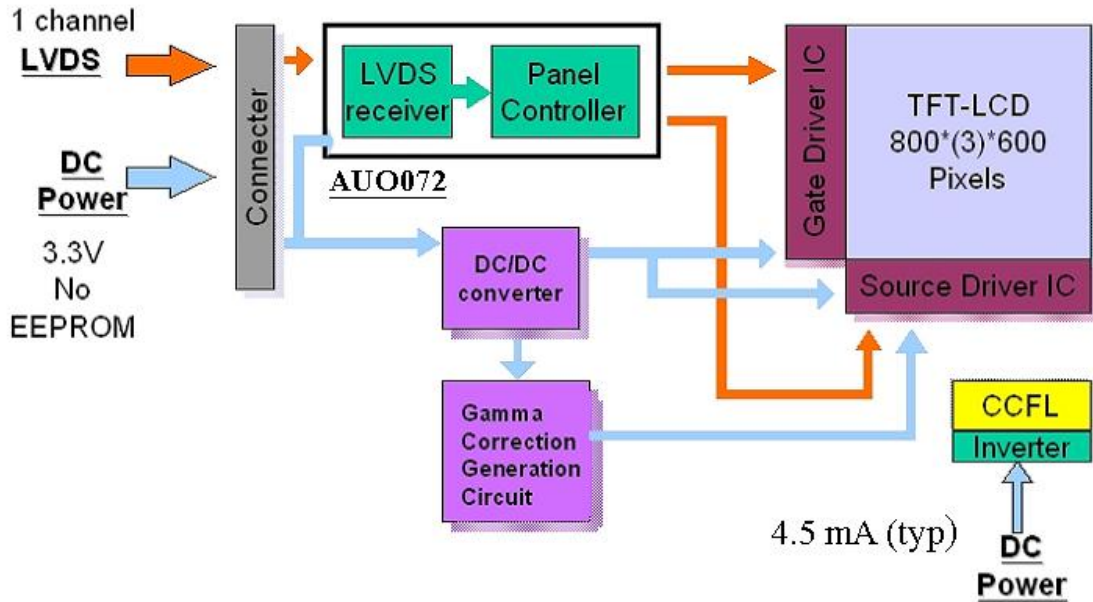





### 3.0 Absolute Maximum Ratings

(GND = 0 V)

Parameter	Symbol	Values		Unit	Remark
		Min.	Max.		
Power voltage	V <sub>DD</sub>	-0.3	4	[Volt]	At 25°C
Input signal voltage	V <sub>in</sub>	-0.3	V <sub>DD</sub> +0.3	[Volt]	At 25°C
CCFL current	ICFL	3.0	5.5	[mA]rms	
CCFL starting Voltage	V <sub>s</sub>	-	800	[Vrms]	AT 25°C
Operating temperature	T <sub>op</sub>	0	+50	[°C]	Note 1
Operating Humidity	H <sub>OP</sub>	8	90	[%RH]	Note 1
Storage temperature	T <sub>ST</sub>	-20	+60	[°C]	Note 1
Storage Humidity	H <sub>ST</sub>	5	90	[%RH]	Note 1
Vibration			1.5,10~200~1	[G,Hz]	
Shock			200,2	[G,ms]	Half sine wave

Note 1: The relative humidity must not exceed 90% non-condensing at temperatures of 40 °C or less. At temperatures greater than 40 °C, the wet bulb temperature must not exceed 39 °C. When operate at low temperatures, the brightness of CCFL will drop and the life time of CCFL will be reduced.

Note 2: The unit should not be exposed to corrosive chemicals.

#### Wet bulb temperature chart

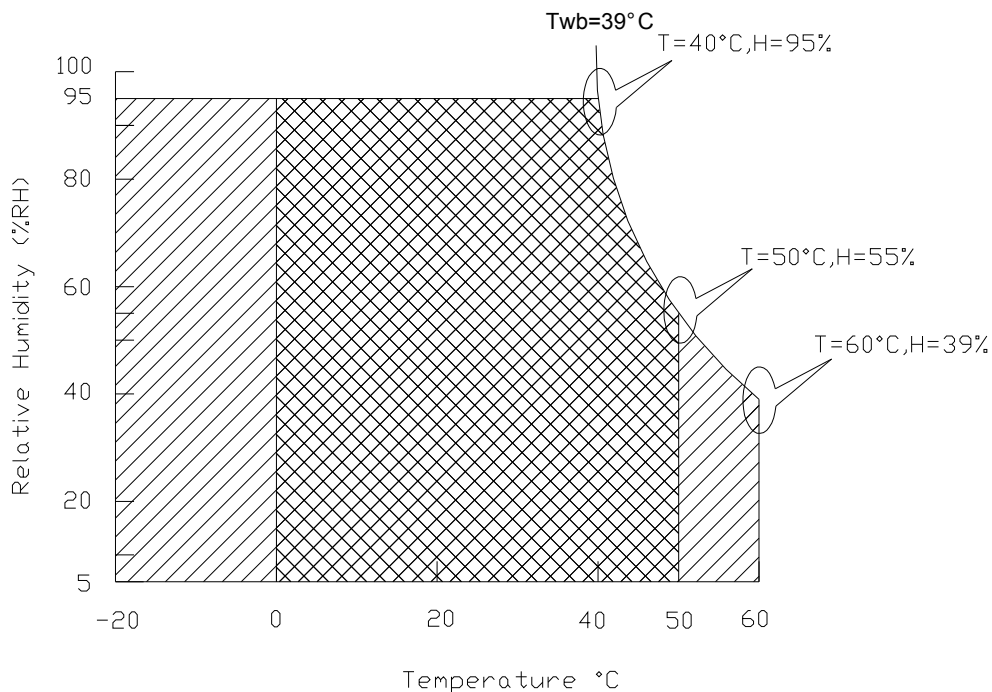

Operating Range

Storage Range +



## 4.0 Optical Characteristics (Note 1, Note 2)

Item	Symbol	Condition	Specification			Unit	Remark
			Min.	Typ.	Max.		
Response time							
Rising time	Tr	$\theta = 0^\circ$	-	10	20	ms	Note 4
Falling time	Tf		-	25	30		
Contrast ratio	CR	$\theta = 0^\circ$	400	500	-		Note 3,5
Viewing angle	Top Bottom Left Right	$CR \geq 10$	30 60 60 60	35 65 60 60	- - - -	deg.	Note 3,6
White Luminance (ICFL=4.5 mA)	[cd/m <sup>2</sup> ]	$\theta = 0^\circ$	200	230	-	nit	Note 3,7,8,9
Color chromaticity(CIE)	Wx	$\theta = 0^\circ$	0.280	0.320	0.340		Note 3,8,9
	Wy		0.300	0.330	0.360		
	Rx		0.540	0.570	0.600		
	Ry		0.290	0.320	0.350		
	Gx		0.270	0.300	0.330		
	Gy		0.530	0.560	0.590		
	Bx		0.115	0.145	0.175		
	By		0.100	0.130	0.160		
White uniformity	$\delta_w$	13 Points	-	-	1.33		Note 3,9,10

Note 1: Ambient temperature = 25°C.

Note 2: To be measured in dark room after backlight warm up 30 minutes.

Note 3: To be measured with a viewing cone of 1° by Topcon luminance meter BM-5A.

Note 4: Definition of response time:

The output signals of BM-7 are measured when the input signals are changed from "Black" to "White" (falling time) and from "White" to "Black" (rising time), respectively. The response time means the interval between the 10% and 90% of amplitudes. Refer to figure as below.

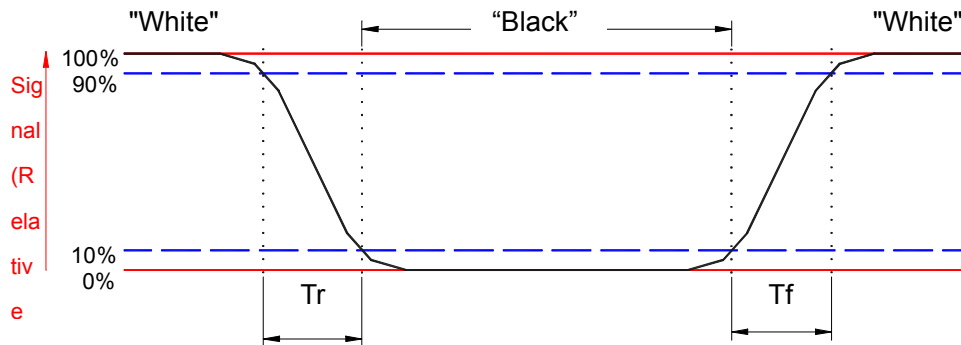

Note 5. Definition of contrast ratio:

Contrast ratio is calculated with the following formula.

$$\text{Contrast ratio (CR)} = \frac{\text{Luminance on the white raster}}{\text{Luminance on the black raster}}$$

Note 6: Definition of viewing angle:

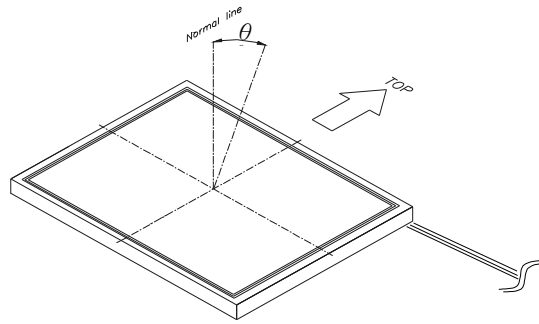

Note 7: Definition of the 13 points (from A to M) on panel, refer to figure as below

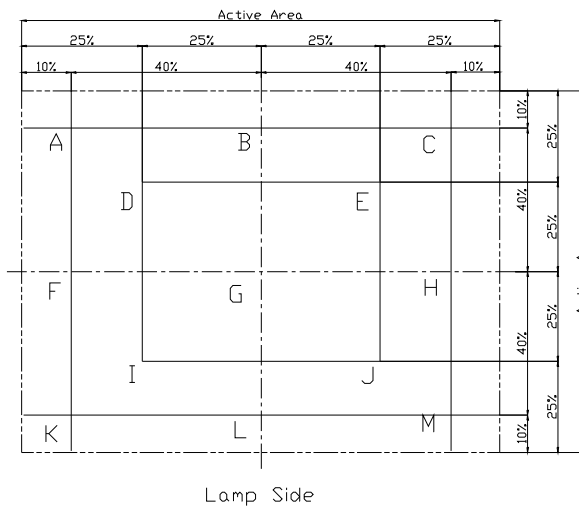

Note 8: Definition of brightness: the luminance of center points (G).

Note 9: Driving conditions for CCFL :  $I_L=4.5$  mA, 60KHz Frequency

Note 10: Definition of white uniformity:

$$\delta_w = \frac{\text{Maximum Luminance of thirteen points (brightness)}}{\text{Minimum Luminance of thirteen points (brightness)}}$$



## 5.0 Signal Interface

### 5.1 Connectors

Physical interface is described as for the connector on module.

These connectors are capable of accommodating the following signals and will be following components.

<b>Connector Name / Designation</b>	For Signal Connector
<b>Manufacturer</b>	HIROSE
<b>Type / Part Number</b>	HRS DF 19K-20P-1H
<b>Mating Connector / Part Number</b>	HRS DF19G-20S-1C (WIRE TYPE))
<b>Mating Connector / Part Number</b>	HRS DF19-20S-1F (FPC TYPE)

<b>Connector Name / Designation</b>	For Lamp Connector
<b>Manufacturer</b>	JST
<b>Type / Part Number</b>	BHSR-02VS-1
<b>Mating Connector / Part Number</b>	SM02B-BHSS-1-TB

### 5.2 Signal Pin

Pin assignment

(1)Input signal interface

Pin no	Symbol	Function	Etc.
1	V <sub>CC</sub>	+3.3 V power supply	
2	V <sub>CC</sub>	+3.3 V power supply	
3	GND	Ground	
4	GND	Ground	
5	RxIN0-	LVDS receiver signal channel 0	
6	RxIN0+		
7	GND	Ground	
8	RxIN1-	LVDS receiver signal channel 1	
9	RxIN1+		
10	GND	Ground	
11	RxIN2-	LVDS receiver signal channel 2	
12	RxIN2+		
13	GND	Ground	
14	CKIN-	LVDS receiver signal clock	
15	CKIN+		
16	GND	Ground	
17	NC	No Connection	
18	NC	No Connection	
19	GND	Ground	
20	GND	Ground	



(2) LVDS transmitter/receiver signal mapping

	Symbol	Function	
TxIN0	R0	Red data (LSB)	6 bit red display data
TxIN1	R1	Red data	
TxIN2	R2	Red data	
TxIN3	R3	Red data	
TxIN4	R4	Red data	
TxIN5	R5	Red data (MSB)	
TxIN6	G0	Green data (LSB)	6 bit green display data
TxIN7	G1	Green data	
TxIN8	G2	Green data	
TxIN9	G3	Green data	
TxIN10	G4	Green data	
TxIN11	G5	Green data (MSB)	
TxIN12	B0	Blue data (LSB)	6 bits blue display data
TxIN13	B1	Blue data	
TxIN14	B2	Blue data	
TxIN15	B3	Blue data	
TxIN16	B4	Blue data	
TxIN17	B5	Blue data (MSB)	
TxIN18	Hs	Horizontal sync.	
TxIN19	Vs	Vertical sync.	
TxIN20	DE	Data enable	
TxCLKIN	CLK	Clock	Dot clock



### 5.3 Signal Description

The module using a LVDS receiver. LVDS is a differential signal technology for LCD interface and high speed data transfer device. Transmitter shall be SN75LVDS84 (negative edge sampling) or compatible.

**Note** : Input signals shall be low or Hi-Z state when VDD is off.

Signal Name	Description
RxIN0-, RxIN0+	LVDS differential data input (Red0-Red5, Green0)
RxIN1-, RxIN1+	LVDS differential data input (Green1-Green5, Blue0-Blue1)
RxIN2-, RxIN2+	LVDS differential data input (Blue2-Blue5, Hsync, Vsync, DE)
CKIN-, CKIN+	LVDS differential clock input
VDD	+3.3V Power Supply
GND	Ground
NC	No Connection

Signal Name	Description	
+RED5 +RED4 +RED3 +RED2 +RED1 +RED0	Red Data 5 (MSB) Red Data 4 Red Data 3 Red Data 2 Red Data 1 Red Data 0 (LSB) Red-pixel Data	Red-pixel Data Each red pixel's brightness data consists of these 6 bits pixel data.
+GREEN5 +GREEN4 +GREEN3 +GREEN2 +GREEN1 +GREEN0	Green Data 5 (MSB) Green Data 4 Green Data 3 Green Data 2 Green Data 1 Green Data 0 (LSB) Green-pixel Data	Green-pixel Data Each green pixel's brightness data consists of these 6 bits pixel data.
+BLUE5 +BLUE4 +BLUE3 +BLUE2 +BLUE1 +BLUE0	Blue Data 5 (MSB) Blue Data 4 Blue Data 3 Blue Data 2 Blue Data 1 Blue Data 0 (LSB) Blue-pixel Data	Blue-pixel Data Each blue pixel's brightness data consists of these 6 bits pixel data.
CLK	Data Clock	The typical frequency is 40MHz. The signal is used to strobe the pixel data and DE signals. All pixel data shall be valid at the falling edge when the DE signal is high.
DE	Display Timing	This signal is strobed at the falling edge of CLK. When the signal is high, the pixel data shall be valid to be displayed.
VSYNC	Vertical Sync	The signal is synchronized to CLK.
HSYNC	Horizontal Sync	The signal is synchronized to CLK.

**Note** : Output signals from any system shall be low or Hi-Z state when VDD is off.

## 5.4 Signal Electrical Characteristics

Input signals shall be low or Hi-Z state when VDD is off.

It is recommended to refer the specifications of SN75LVDS86(Texas Instruments) in detail.

Signal electrical characteristics are as follows :

Item	Symbol	Min.	Typ.	Max.	Unit
The differential level	$ VID $	0.1	-	0.6	V
The common mode input voltage	VIC	$\frac{ VID }{2}$	-	$2.4 - \frac{ VID }{2}$	V
The input setup time	tsu	0.5	-	-	ns
The input hold time	thd	0.5	-	-	ns
High-level input voltage	V <sub>IAP</sub>	2.0			V
Low-level input voltage	V <sub>IAM</sub>			0.8	V
Clock frequency	CLK	31		68	MHz

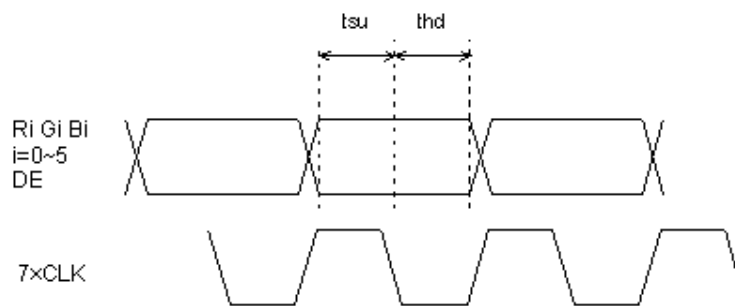
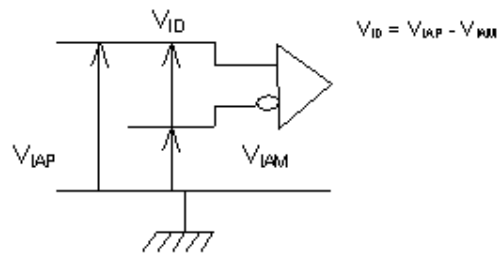



## 6.0 Pixel Format Image

Following figure shows the relationship of the input signals and LCD pixel format :

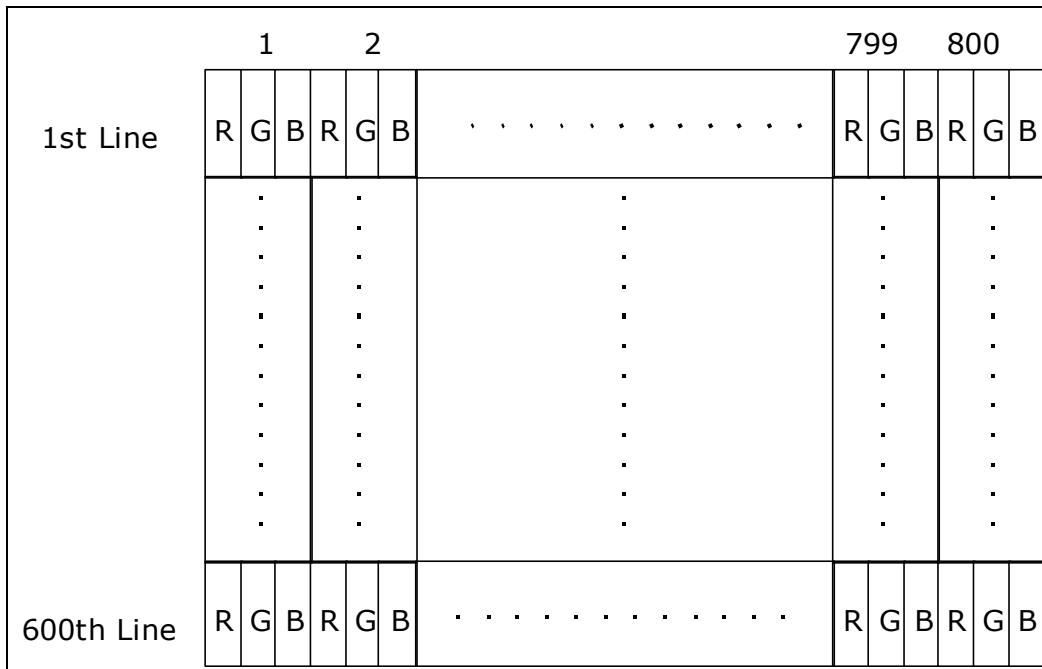





## 7.0 Power Consumption

Input power specifications are as follows :

Item		Symbol	Min.	Typ.	Max.	Unit	Remark
Power supply voltage	Input voltage	$V_{CC}$	3.0	3.3	3.6	V	
	Current consumption	$I_A$		230		mArms	Note 1
		$I_B$			260	310	
	Inrush current	$I_{RUSH}$	-	-	1500	mApeak	Note 2
Internal logic	Low voltage	$V_{IL}$	0	-	$0.3 V_{CC}$		
	High voltage	$V_{IH}$	$0.7V_{CC}$	-	$V_{CC}$		
Power ripple voltage		$V_{RP}$	-	-	100	mVp-p	
LCD Drive power consumption		$P_{DD}$		0.76		[Watt]	

Note 1: Effective value (mArms) at  $V_{CC} = 3.3 V/25^{\circ}C$ .

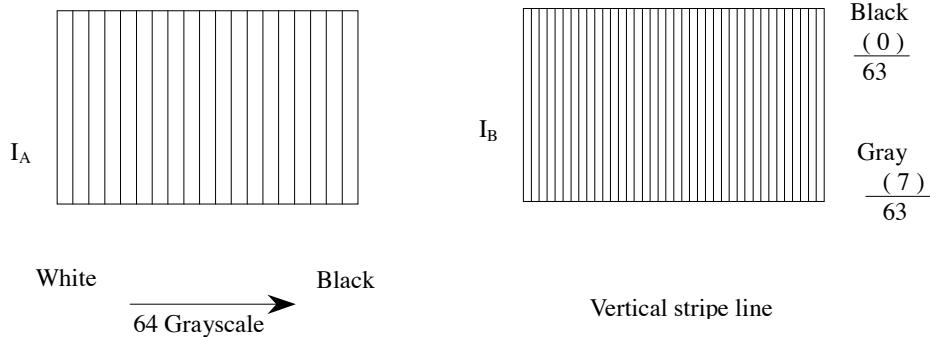

Note 2: Refer to the following power-on condition.

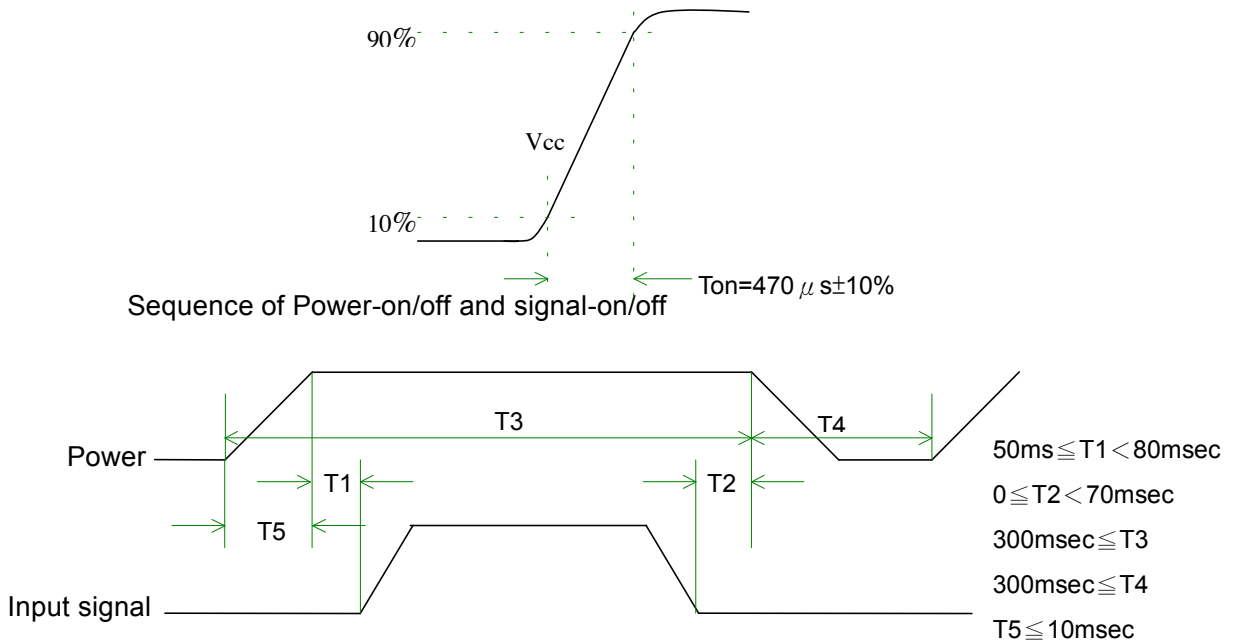



Apply the lamp voltage within the LCD operating range. When the backlight turns on before the LCD operation or the LCD turns off before the backlight turns off, the display may momentarily become abnormal.

**Caution**

The above on/off sequence should be applied to avoid abnormal function in the display.  
In case of handling:  
Make sure to turn off the power when you plug the cable into the input connector or pull the cable out of the connector.



## 8.0 Interface Timings

### 8.1 Display color v.s. input data signals:

Display colors		Data signal (0 : Low level, 1: High level)																	
		R5	R4	R3	R2	R1	R0	G5	G4	G3	G2	G1	G0	B5	B4	B3	B2	B1	B0
Basic colors	Black	0	0	0	0	0	0	0	0	0	0	0	0	0	0	0	0	0	0
	Blue	0	0	0	0	0	0	0	0	0	0	0	0	1	1	1	1	1	1
	Red	1	1	1	1	1	1	0	0	0	0	0	0	0	0	0	0	0	0
	Magenta	1	1	1	1	1	1	0	0	0	0	0	0	1	1	1	1	1	1
	Green	0	0	0	0	0	0	1	1	1	1	1	1	0	0	0	0	0	0
	Cyan	0	0	0	0	0	0	1	1	1	1	1	1	1	1	1	1	1	1
	Yellow	1	1	1	1	1	1	1	1	1	1	1	1	0	0	0	0	0	0
	White	1	1	1	1	1	1	1	1	1	1	1	1	1	1	1	1	1	1
Red grayscale	Black	0	0	0	0	0	0	0	0	0	0	0	0	0	0	0	0	0	0
	Dark	0	0	0	0	0	1	0	0	0	0	0	0	0	0	0	0	0	0
	↑																		
	↓																		
	bright	1	1	1	1	0	1	0	0	0	0	0	0	0	0	0	0	0	0
Red	1	1	1	1	1	0	0	0	0	0	0	0	0	0	0	0	0	0	
Green grayscale	Black	0	0	0	0	0	0	0	0	0	0	0	0	0	0	0	0	0	0
	Dark	0	0	0	0	0	0	0	0	0	1	0	0	0	0	0	0	0	0
	↑																		
	↓																		
	bright	0	0	0	0	0	0	1	1	1	1	0	1	0	0	0	0	0	0
Green	0	0	0	0	0	0	1	1	1	1	1	1	0	0	0	0	0	0	
Blue grayscale	Black	0	0	0	0	0	0	0	0	0	0	0	0	0	0	0	0	0	0
	Dark	0	0	0	0	0	0	0	0	0	0	0	0	0	0	0	0	1	0
	↑																		
	↓																		
	bright	0	0	0	0	0	0	0	0	0	0	0	0	1	1	1	1	0	1
Blue	0	0	0	0	0	0	0	0	0	0	0	0	1	1	1	1	1	1	

Note : Each basic color can be displayed in 64 gray scales using the 6 bit data signals. By combining the 18-bit data signals(R, G, B), the 262, 144 colors can be achieved on the display.



## 8.2. Input signal timing

(1). Timing characteristics of input signals

(a) DE mode

Item	Symbol	Min.	Typ.	Max.	Unit	Remark
Clock frequency	Fck	36	40	50	MHz	
Horizontal blanking	Thb1	18	256	624	Clk	
Vertical blanking	Tvb1	3	28	184	Th	

(b) HV mode

Item	Symbol	Min.	Typ.	Max.	Unit	Remark
Clock frequency	Fck	36	40	50	MHz	
Hsync period	Th	818	1056	1424	Clk	
Hsync pulse width	Thw	2	128	-	Clk	
Hsync front porch	Thf	8	40	-	Clk	
Hsync back porch	Thb	4	88	-	Clk	
Hsync blanking	Thb1	18	256	624	Clk	
Vsync period	Tv	603	628	784	Th	
Vsync pulse width	Tvw	1	4	-	Th	
Vsync front porch	Tvf	0	1	-	Th	
Vsync blanking	Tvb1	3	28	184	Th	
Hsync/Vsync phase shift	Tvpd	2	320	-	Clk	

Item	Symbo	Value	Unit	Description
Horizontal display start	The	218	Clk	After falling edge of Hsync, counting 218clk, then getting valid data from 219th clk's data.
Vertical display start	Tve	25	Th	After falling edge of Vsync, counting 25th, then getting 26th Th's data.

(2). Timing Definition:

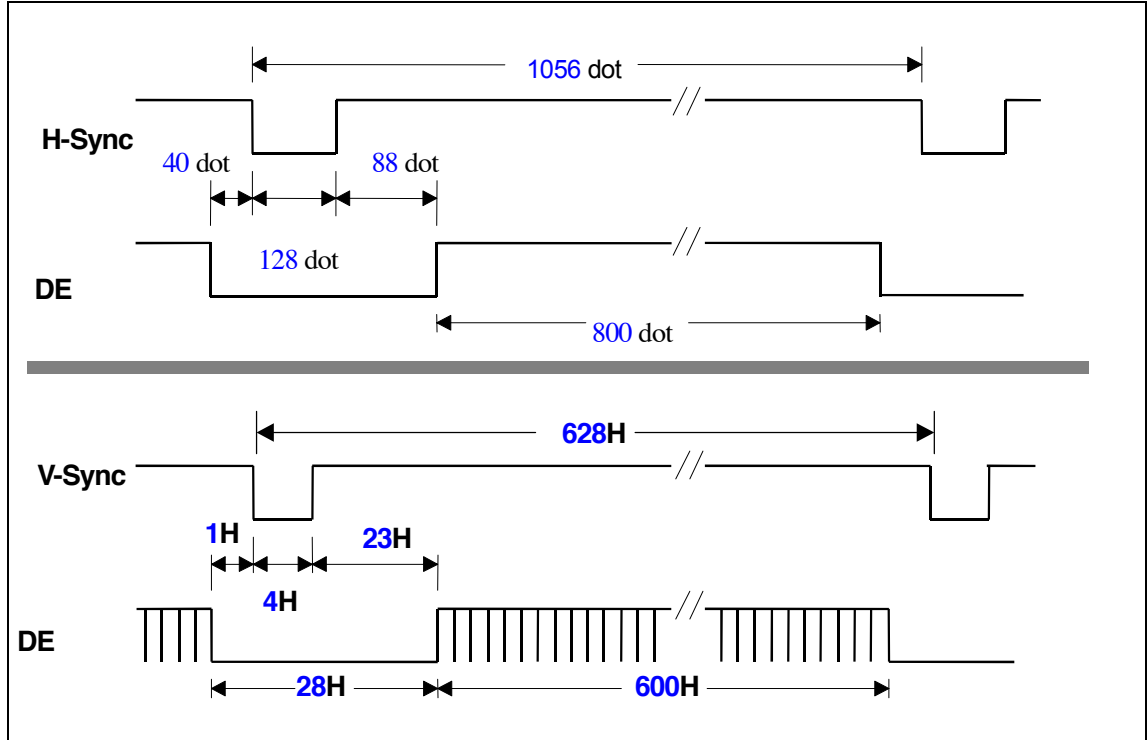

(3)Timing Chart:

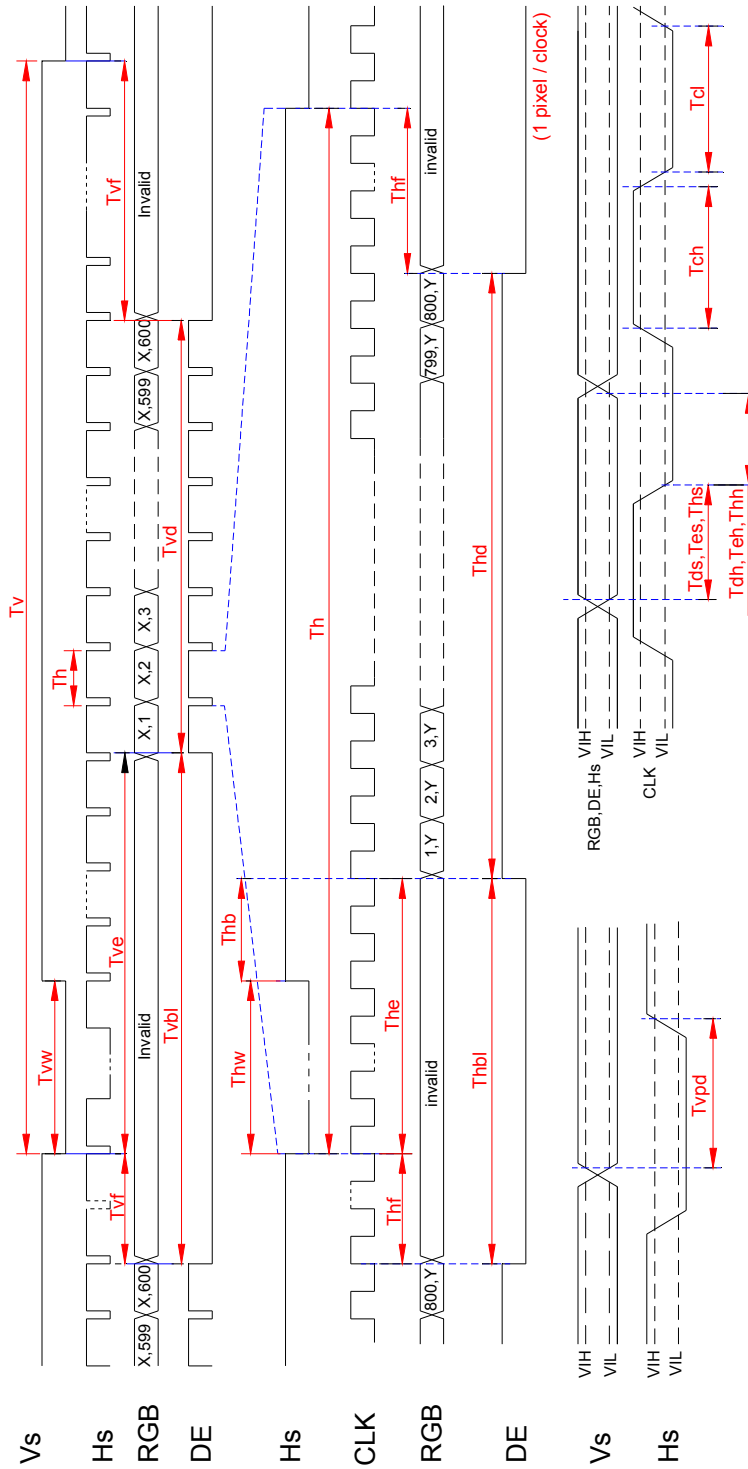

Timing chart



### 8.3. Display position

D( 1,1 )	D( 2,1 )	.....	D( X,1 )	.....	D( 799,1 )	D( 800,1 )
D( 1,2 )	D( 2,2 )	.....	D( X,2 )	.....	D( 799,2 )	D( 800,2 )
⋮		.....	⋮	.....	⋮	⋮
D( 1,Y )	D( 2,Y )	.....	D( X,Y )	.....	D( 799,Y )	D( 800,Y )
⋮		.....	⋮	.....	⋮	⋮
D( 1,599 )	D( 2,599 )	.....	D( X,599 )	.....	D( 799,599 )	D( 800,599 )
D( 1,600 )	D( 2,600 )	.....	D( X,600 )	.....	D( 799,600 )	D( 800,600 )

## 9.0 Backlight Characteristic

Backlight driving conditions

Parameter	Symbol	Min.	Typ.	Max.	Unit	Remark
Lamp voltage	$V_L$	510	560	610	Vrms	Note 1
Lamp current	$I_L$	3.0	4.5	5.5	mArms	Note 1
Power consumption	$P_L$	-	2.52	-	W	Note 2
Lamp starting voltage	$V_S$	-	-	1050	Vrms	T=0°C
		-	-	800		T=25°C
Frequency	$F_L$	-	60	-	KHz	Note 3
Lamp life time	$L_L$	10000	20000	-	Hr	Note 1, 4

Note 1: T= 25°C,  $I_L$  = 4.5mA

Note 2: Inverter should be designed with the characteristic of lamp. When you are designing the inverter, the output voltage of the inverter should comply with the following conditions.

- (1). The area under the positive and negative cycles of the waveform of the lamp current and lamp voltage should be area symmetric(the symmetric ratio should be larger than 90%).
- (2). There should not be any spikes in the waveform.
- (3). The waveform should be sine wave as possible.
- (4). Lamp current should not exceed the maximum value within the operating Temperature (It is prohibited to over the maximum lamp current even if operated in The non-guaranteed temperature). When lamp current over the maximum value for a long time, it may cause fire. Therefore, it is recommend that the inverter should have the current limited circuit.

Note 3: Lamp frequency may produce interference with horizontal synchronous frequency and this may cause line flow on the display. Therefore lamp frequency shall be detached from the horizontal synchronous frequency and its harmonics as far as possible in order to avoid interference.

Note 4: Brightness ( $I_L=4.5mA$ ) to be decrease to the 50% of the initial value.

### Signal for Lamp connector

Pin no.	Symbol	Function	Remark
1	H	CCFL power supply(H.V.)	Cable color: Pink
2	L	CCFL power supply(GND)	Cable color: White



## 10.0 Reliability test items

Test tem	Test Condition	Remark
High temperature storage	70°C , 300Hrs	Note 1, 2 , 3
Low temperature storage	-20°C , 300Hrs	Note 1, 2 , 3
High temperature & high humidity operation	40°C , 90%RH, 300Hrs (No condensation)	Note 1, 2 , 3
High temperature operation	50°C , 300Hrs	Note 1, 2 , 3
Low temperature operation	0°C , 300Hrs	Note 1, 2 , 3
Temperature cycling (non-operation)	-20°C~60°C 1H, 10mins, 1H, 5cycles	Note 1, 2 , 3
Electrostatic discharge (non-operation)	150 pF, 150Ω, 10kV, 1 second, 8 position on the panel, 10 times each place	Note 3
Vibration (non-operation)	Sweep: 1.5G, 10Hz~ 200Hz~ 10Hz /2.5min X, Y, Z, 3 directions	Note 1, 2 , 3
Mechanical shock (non-operation)	50G/18ms, 200G/2ms, ±X, ±Y, ±Z once for each direction	Note 1, 2 , 3

Note 1: Evaluation should be tested after storage at room temperature for one hour.

Note 2: There should be no change which might affect the practical display function when the display quality test is conducted under normal operating condition.

Note 3: Judgment: 1. Function OK

2. No serious image quality degradation

## 11.0 Display quality

The display quality of the color TFT-LCD module should be in compliance with the AUO's OQC inspection standard.





## 12.0 Packing Dimension:

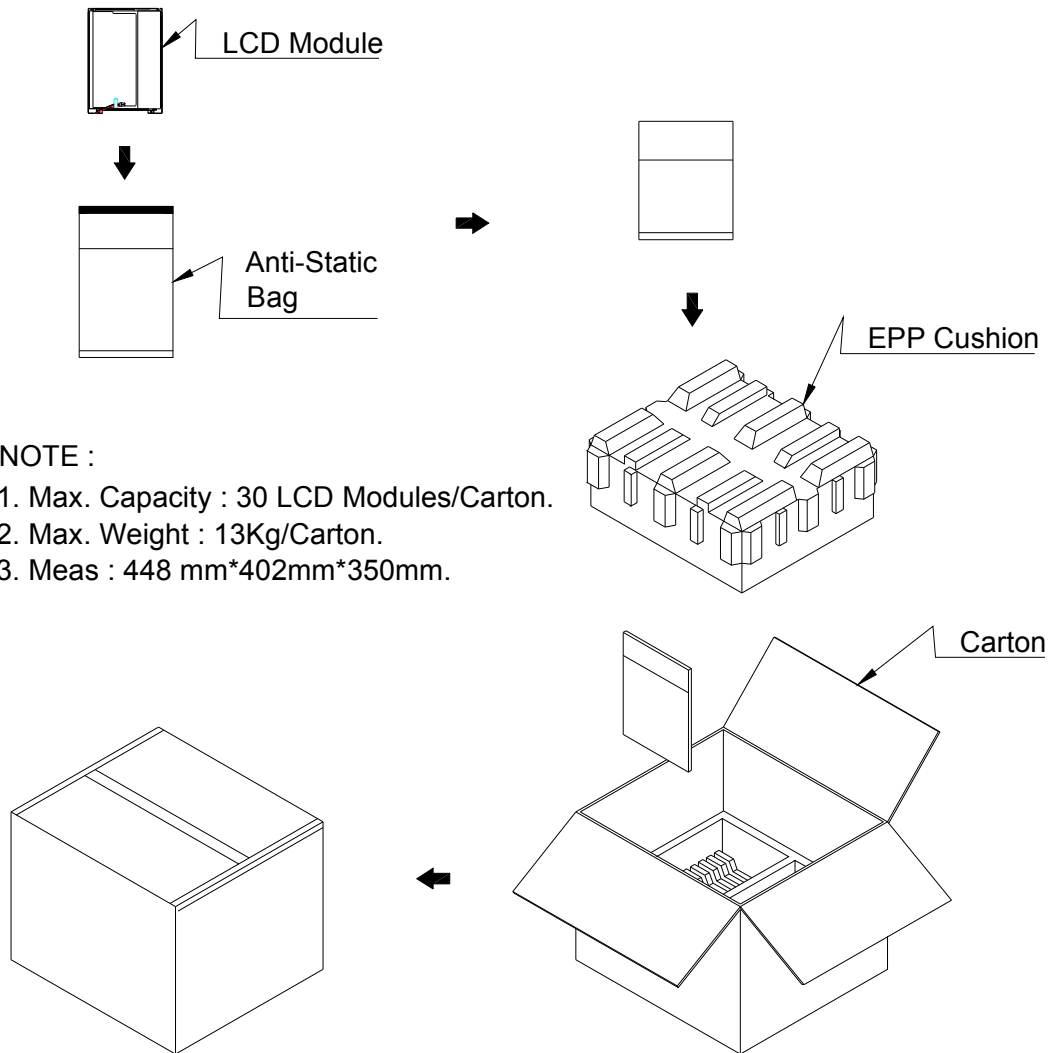

**NOTE :**

1. Max. Capacity : 30 LCD Modules/Carton.
2. Max. Weight : 13Kg/Carton.
3. Meas : 448 mm\*402mm\*350mm.



# 13.0 Mechanical Characteristic

## LCM outline dimensions

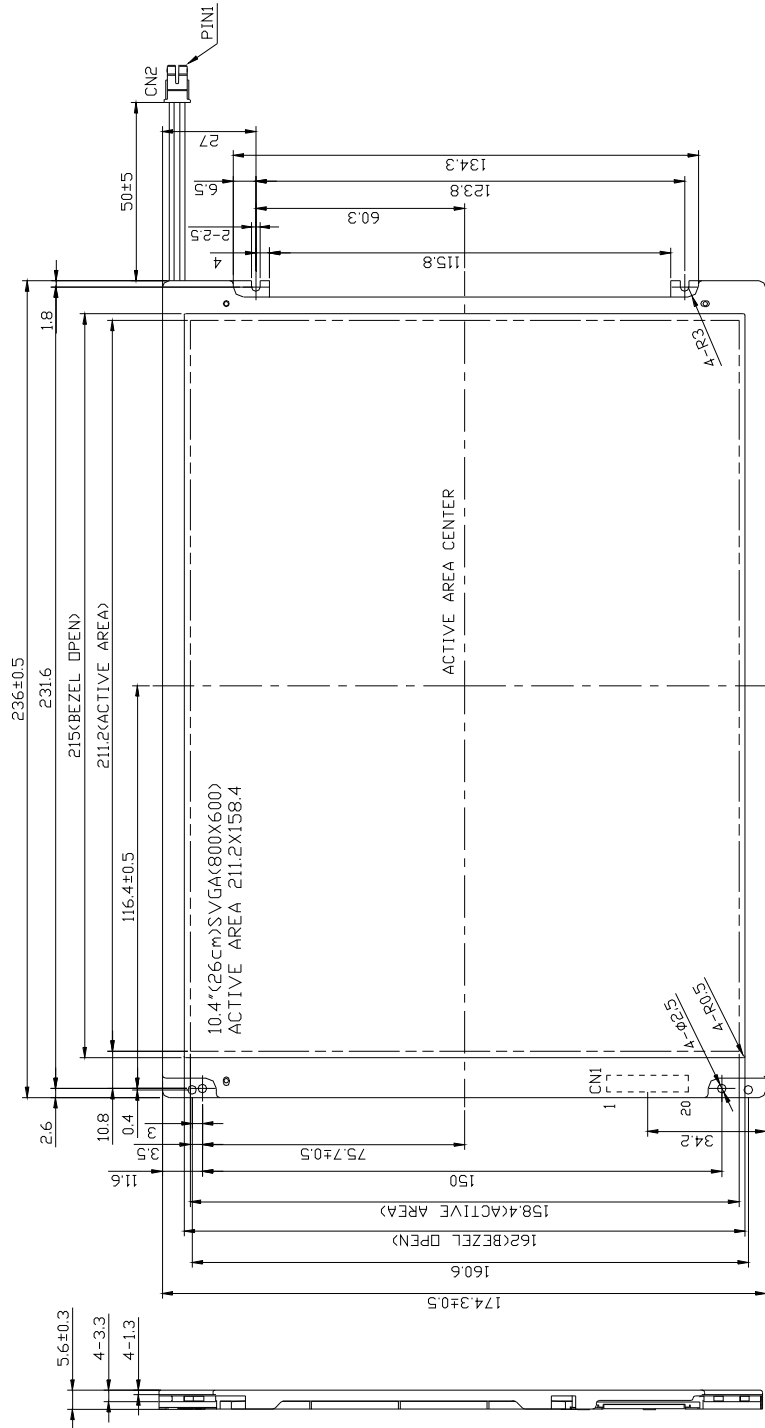

- NOTES:
- UNSPECIFIED TOLERANCE TO BE  $\pm 0.3$
  - CONNECTOR TYPE:  
 CN1(20P) CONNECTOR:HRS DF 19K-20P-1H  
 CN2(BACKLIGHT)CONNECTOR:JST BHSR-02VS-1  
 MATING CONNECTOR:JST SM02B-BHSS-1-TB