

LQ064V3DG01

TFT-LCD Module

Spec. Issue Date: November 2, 2006

No: LA1-04032E

PREPARED BY: <i>K. Togo</i>	SHARP	SPEC No. LA1-04032E
APPROVED BY: <i>K. Yamuchi</i>		FILE No.
	MOBILE LIQUID CRYSTAL DISPLAY GROUP	ISSUED: Nov.2.2006
	SHARP CORPORATION	PAGE : 18 pages
	SPECIFICATION	APPLICABLE GROUP
		MOBILE LIQUID CRYSTAL DISPLAY GROUP

DEVICE SPECIFICATION FOR
TFT-LCD module
 MODEL No. LQ064V3DG01

CUSTOMER'S APPROVAL

DATE _____

BY _____

PRESENTED

BY *H. Hamada* _____

H. HAMADA
 Department General manager
 Engineering Department. 1
 Mobile LCD Design Center
 Mobile Liquid Crystal Display Group. 1
 SHARP CORPORATION

RECORDS OF REVISION

MODEL No : LQ064V3DG01

SPEC No : LA1-04032E

	NO.	PAGE	SUMMARY	NOTE				
2004.11.16		-	-	1 st Issue				
2004.12.01	A	4	Topo=0~55°C→10~55°C	2 nd Issue				
		10	Response time					
			Tr(typ)30→8ms(max)60→20ms Td(typ)50→21ms(max)100→40ms					
2005.2.5	B	4,7	The note of caution of terminals of inverter is added.	3 rd Issue				
2005.5.16	C	3	·Corresponding connector is revised. CF9A→DF9A,CF9B→DF9B,CF9C→DF9C	4 th Issue				
			·Vcc function is added. Power supply in →Power supply in(Supply the same voltage to Pin No.28 and No.29)					
			4		·Operating temperature(Ambient) is deleted.			
		10	·Contrast ratio is changed. Min 150→250 , TYP 250→350					
			16		·Specification of the front shield case opening area is added.			
		2006.3.28			D	4,15	·Operation temperature (Panel surface)-10°C~70°C → -30°C~80°C	5 th Issue
·Vibration test Frequency : 10~57Hz /Vibration width(one side)0.075mm→0.15mm :58~500Hz / acceleration 9.8m/s ² → 19.6m/s ²								
·Shock test Max acceleration: 490m/s ² → 980m/s ² Pulse width:11ms → 6ms								
2006.11.2	E		3	Addition: The [Note4-2] of Input Signal Assignment		6 th Issue		
			7	Addition: Kick-off voltage(Ta=-30°C)				
			8	Addition: The [Note7-1] of timing characteristics				
			10 10	Change : Response time Tr(typ)30→8ms, (max)60→20ms Td(typ)50→21ms, (max)100→40ms				
				12			Change: The distance between the blower and the module	
				13			Addition: Others 11-4) text	
		15	Addition: Note of Low temperature operation test					

NOTICE

This publication is the proprietary of SHARP and is copyrighted, with all rights reserved. Under the copyright laws, no part of this publication may be reproduced or transmitted in any form or by any means, electronic or mechanical for any purpose, in whole or in part, without the express written permission of SHARP. Express written permission is also required before any use of this publication may be made by a third party.

The application circuit examples in this publication are provided to explain the representative applications of SHARP's devices and are not intended to guarantee any circuit design or permit any industrial property right or other rights to be executed. SHARP takes no responsibility for any problems related to any industrial property right or a third party resulting from the use of SHARP's devices, except for those resulting directly from device manufacturing processes.

In the absence of confirmation by device specification sheets, SHARP takes no responsibility for any defects that occur in equipment using any of SHARP's devices, shown in catalogs, data books, etc. Contact SHARP in order to obtain the latest device specification sheets before using any SHARP's device.

SHARP reserves the right to make changes in the specifications, characteristics, data, materials, structures and other contents described herein at any time without notice in order to improve design or reliability. Contact SHARP in order to obtain the latest specification sheets before using any SHARP's device. Manufacturing locations are also subject to change without notice.

Observe the following points when using any device in this publication. SHARP takes no responsibility for damage caused by improper use of the devices.

The devices in this publication are designed for general electronic equipment use.

The appropriate design measures should be taken to ensure reliability and safety when SHARP's devices are used for equipment such as:

- Transportation control and safety equipment (i.e., aircraft, trains, automobiles, etc.)
- Traffic signals • Gas leakage sensor breakers • Alarm equipment • Various safety devices etc.

SHARP's devices shall not be used for equipment that requires extremely high level of reliability, such as:

- Military and space applications • Nuclear power control equipment
- Medical equipment for life support

Contact a SHARP representative, in advance, when intending to use SHARP's devices for any "specific" applications other than those recommended by SHARP.

Contact and consult with a SHARP representative if there are any questions about the contents of this publication.

1 Applicable TFT-LCD module

This specification applies to the color TFT-LCD module, LQ064V3DG01.

2 Overview

This module is a color active matrix transmissive LCD module incorporating amorphous silicon TFT (Thin Film Transistor).

It is composed of a color TFT-LCD panel, driver ICs, control circuits and power supply circuitry and a backlight unit. Graphics and texts can be displayed on a 640 x RGB x 480 dots panel with 262,144 colors by feeding 18 bit data signal (6bit/each of R,G,B), 4(four) timing signals, +3.3V or +5V DC power supply for TFT-LCD and AC power supply for backlight.

(Note: Backlight-driving DC/AC inverter is not built in this module.)

- Fine images with stripe aligned 307,200 pixels on 6.4 inch diagonal screen
- Color display capability of 262,144 colors with 18 bit data signal(6 bits for each RGB)
- Adapting a wide viewing angle technology [best viewing angle: 6 o'clock direction]
- High contrast, thanks to active matrix drive system
- AG(Anti Glare) polarizing filter
- Light and slim compact module achieved by COG assemble technology(12 o'clock direction is also available by the function to flip the screen horizontally or vertically)
- Natural coloring reproducibility by employing normally-white-mode, which has good nature in coloring
- Image inversion both horizontally and vertically

3 Mechanical Specifications

items	specifications	unit
Display size (Diagonal)	16.32 (6.4")	cm
Active display area	130.56 (H) x 97.92 (V)	mm
Pixel format	640(H) x RGB x 480(V)	dot
	(1 pixel=R+G+B dots)	-
Pixel pitch	0.204 (H) x 0.204(V)	mm
Pixel configuration	R,G,B vertical stripe	-
LCD mode	Normally white/Twisted Nematic	-
Dimension *	161.3 (W) x 117 (H) x 12(D)	mm
Mass	280 (max)	g

*. Protrusion such as backlight harness and positioning boss are not included.

Fig.1 shows dimensions of the module.

4 Input Signal Assignment

4.1 TFT-LCD Panel driving section



CN1 pin arrangement from module surface
(Transparent view)

Employed connector: DF9BA31P-1V(32) (HIROSE ELECTRIC)

Corresponding connector: DF9 -31S-1V(32), DF9A-31S-1V(22)

DF9B-31S-1V(32), DF9C-31S-1V(22) (HIROSE ELECTRIC)

Pin No.	Symbol	Function	Polarity
1	GND	—	
2	CK	Clock signal for sampling each datum	
3	Hsync	Horizontal Sync signal	Negative
4	Vsync	Vertical Sync signal	Negative
5	GND		
6	R0	RED Data signal (LSB)	
7	R1	RED Data signal	
8	R2	RED Data signal	
9	R3	RED Data signal	
10	R4	RED Data signal	
11	R5	RED Data signal (MSB)	
12	GND		
13	G0	GREEN data signal (LSB)	
14	G1	GREEN data signal	
15	G2	GREEN data signal	
16	G3	GREEN data signal	
17	G4	GREEN data signal	
18	G5	GREEN data signal (MSB)	
19	GND		
20	B0	BLUE data signal (LSB)	
21	B1	BLUE data signal	
22	B2	BLUE data signal	
23	B3	BLUE data signal	
24	B4	BLUE data signal	
25	B5	BLUE data signal (MSB)	
26	GND		
27	ENAB	Data Enable signal (Control signal for image location in horizontal direction)	[Note 1]
28	Vcc	Power supply in (Please supply the same voltage to Pin28 and Pin29.)	
29			
30	R/L	Horizontal scanning direction control signal (built in pull-up resistor)	[Note 2,3]
31	U/D	Vertical scanning direction control signal (built in pull-up resistor)	[Note 2,3]

The back shield case is internally grounded to GND of the module.

The front shield case is not certainly grounded to GND of the module.

[Note 1]

The horizontal display location is designated and controlled by rising timing of ENAB signal. However if ENAB signal is fixed to “Low”, display location is designated by the default setting in the module. (Don’t use the module by fixing ENAB to “High”)See: Chapter 7-2

[Note 2]

When opening it, it becomes set of High because the pull-up resistor is built into the module.

[Note 3]

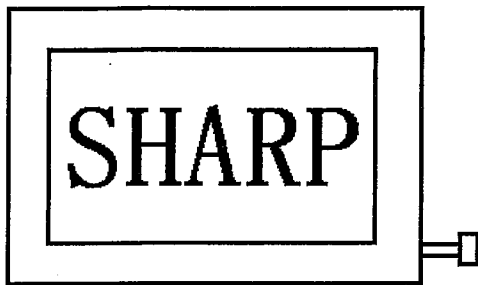

(R/L=High, U/D=High)

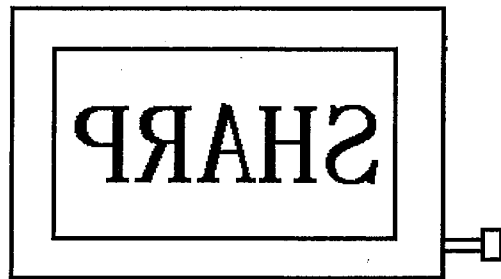

(R/L=Low, U/D=High)

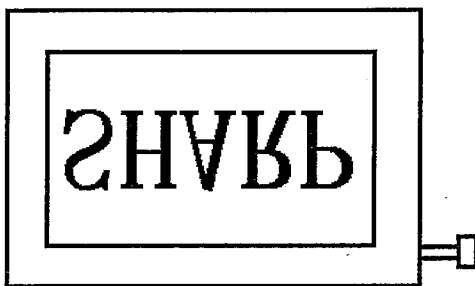

(R/L=High, U/D=Low)

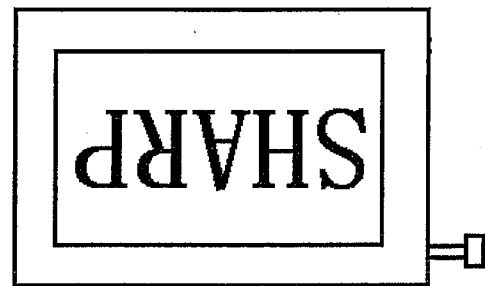

(R/L=Low, U/D=Low)

4.2 Backlight section

Employed connector: BHR-04VS-1 (JST)

CN2

Adapted connector: SM04 (4.0) B-BHS-1 (JST)

Pin no.	Symbol	Function
1	V _{HIGH}	Power supply for lamp (High voltage side)
2	V _{HIGH}	Power supply for lamp (High voltage side)
3	NC	This is electrically opened.
4	V _{LOW}	Power supply for lamp (Low voltage side)

※ The input voltage wave forms to terminal ① and terminal ② should be in a same phase.

It has the possibility to discharge abnormally between the terminals in case of input in a reversed phase.

5 Absolute Maximum Ratings

Parameter	Symbol	Condition	Ratings	Unit	Remark
Input voltage	V _I	T _a =25°C	-0.3 ~ +6	V	[Note 1]
Supply voltage	V _{CC}	T _a =25°C	0 ~ +6	V	-
Storage temperature	T _{stg}	-	-30 ~ +80	°C	[Note 2]
Operating temperature (Panel surface)	T _{opp}	-	-30 ~ +80	°C	

[Note 1] CK, R0 ~ R5, G0 ~ G5, B0 ~ B5, Hsync, Vsync, ENAB, R/L and U/D

[Note 2] Humidity: Less than 95%RH at T_a ≤ 40°C and

Maximum wet-bulb temperature must not exceed 39°C at T_a > 40°C,
with no condensation.

6 Electrical characteristics

6.1 TFT-LCD Panel driving section

Ta=25°C

Parameter	Symbol	Min	Typ	Max	Unit	Remarks
Supply voltage	V _{CC}	+3.0	+3.3	+3.6	V	[Note1]
	V _{CC}	+4.5	+5.0	+5.5	V	
Current dissipation	I _{CC}	-	290	580	mA	[Note2] V _{CC} =3.3V
	I _{CC}	-	200	400	mA	[Note2] V _{CC} =5.0V
Allowed input ripple voltage	V _{RF}	-	-	100	mV p-p	V _{CC} =5V/3.3V
Input voltage ("Low" state)	V _{IL}	- 0.3	-	0.9	V	[Note3]
Input voltage ("High" state)	V _{IH}	2.3	-	5.5	V	
Input leakage current (low)	I _{OL1}	-	-	1.0	μA	V _{CC} =3.3V V _I =0V
	[Note4]	-	-	1.0	μA	V _{CC} =5.0V V _I =0V
	I _{OL2}	-	-	6.0	μA	V _{CC} =3.3V V _I =0V
	[Note5]	-	-	7.0	μA	V _{CC} =5.0V V _I =0V
	I _{OL3}	-	-	120	μA	V _{CC} =3.3V V _I =0V
	[Note6]	-	-	180	μA	V _{CC} =5.0V V _I =0V
	I _{OL4}	-	-	6.0	μA	V _{CC} =3.3V V _I =0V
	[Note7]	-	-	6.0	μA	V _{CC} =5.0V V _I =0V
Input leakage current (High)	I _{OH1}	-	-	1.0	μA	V _{CC} =3.3V V _I =3.3V
	[Note4]	-	-	1.0	μA	V _{CC} =5.0V V _I =5.0V
	I _{OH2}	-	-	6.0	μA	V _{CC} =3.3V V _I =3.3V
	[Note5]	-	-	7.0	μA	V _{CC} =5.0V V _I =5.0V
	I _{OH3}	-	-	40	μA	V _{CC} =3.3V V _I =3.3V
	[Note6]	-	-	80	μA	V _{CC} =5.0V V _I =5.0V
	I _{OH3}	-	-	6.0	μA	V _{CC} =3.3V V _I =3.3V
	[Note7]	-	-	6.0	μA	V _{CC} =5.0V V _I =5.0V

[Note1] V_{CC} turn-on/off conditions

- 0 < t₁ ≤ 15ms
- 0 < t₂ ≤ 20ms
- 0 < t₃ ≤ 1s
- 1s < t₄

V_{CC}-dip conditions

- 1) At 2.7V ≤ V_{CC} < 3.0V
t_d ≤ 10ms
- 2) At V_{CC} < 2.7V

V_{CC} dip conditions should also follow the V_{CC} turn-on/off conditions

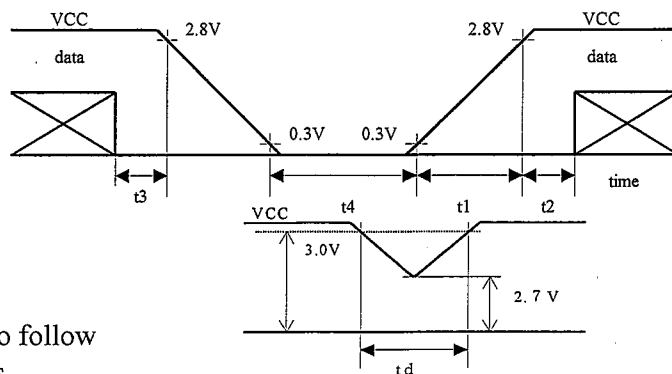

[Note2] Current dissipation (Typ.):

When Monochrome 16 level-gray-bar pattern is displayed (Figure below, Refer Page 10 for details of RGB)

Current dissipation (Max.):

When GS3 and GS10 gray bar are displayed alternately.

[Note3] CK, R0~R5, G0~G5, B0~B5, Hsync, Vsync, ENAB, R/L and U/D

[Note4] R0~R5, G0~G5, B0~B5, Hsync, and Vsync

[Note5] ENAB [Note6] R/L and U/D [Note7] CK

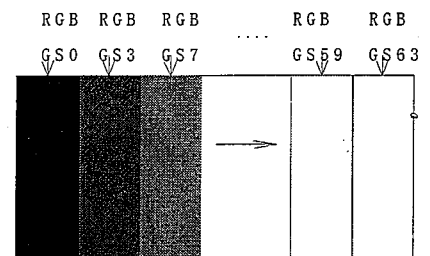

6.2 Backlight driving Section

Ta=25°C

Parameter	Symbol	Min.	Typ.	Max.	Unit	Remarks
Lamp voltage	VL	330	370	410	V rms	$I_L=5 \times 2\text{mA rms}$
Lamp current	IL	9.0	10.0	11.0	mA rms	$5\text{mA rms} \times 2$ [Note6-1]
Lamp frequency	fL	35	-	80	KHz	Recommend
Kick-off voltage [Note6-1]	Vs	-	-	(785)	V rms	Ta=-30°C [Note6-2]
		-	-	660		Ta=-10°C [Note6-2]
		-	-	530		Ta=25°C [Note6-2]
		-	-	(1015)		Ta=-30°C [Note6-2]
		-	-	960		Ta=-10°C [Note6-3]
		-	-	770		Ta=25°C [Note6-3]
Lamp life time	LL	-	50,000	-	hour	[Note6-4]

(Inverter: HARISON TOSHIBA LIGHTING CORPORATION Type HIU-359A-S2(18pF) is used at drive frequency $f=50\text{kHz}$)

Caution: Use Inverter providing symmetrical sine-wave in positive/negative polarity with no spike.

[Note6-1] Connect Module's metal shield case to GND of inverter circuit.

There are two lamps in back light. A piece of lamp current is 5mA rms.

Lamp current is measured with current meter for high frequency as shown below.

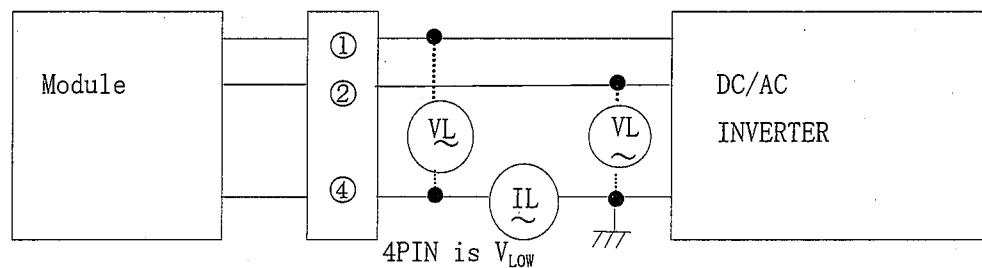

[Note6-2] The voltage at the output of inverter circuitry.

The open output voltage of the inverter shall be maintained for more than 1sec; otherwise the lamp may not be turned on.

The input voltage wave forms to terminal ① and terminal ② should be in a same phase. It has the possibility to discharge abnormally between the terminals in case of input of a reversed phase.

For the sake of the safety, please so design the inverter as to prevent abnormal discharge when one of the two lamps is broken or reaches the end of life.

[Note6-3] The voltage at the output of transformer built in inverter circuitry

[Note6-4] The data for lamp is for your reference, because lamp is consumable component.

a) Lamp life time is defined by either 1 or 2 below. (Continuous turning on at Ta=25°C, $I_L=5 \times 2\text{mA rms}$)

① When a brightness of lamp surface became 50% of the initial value under the standard condition.

② When a kick-off voltage in Ta= -10°C exceeded maximum value (960 Vrms) at the output of inverter circuitry

b) In case of operating under lower temp. environment, the lamp exhaustion is accelerated and the brightness becomes lower.

(Continuous operating for around 1 month under lower temp. condition may reduce the brightness to half of the original brightness.)

In case of such usage under lower temp. environment, periodical lampexchange is recommended

7 Timing Characteristics of Input Signals

Timing diagrams of input signal are shown in Fig.2.

7.1 Timing Characteristics

Parameter		Symbol	Min.	Typ.	Max.	Unit	Note
Clock	Frequency	1/Tc	-	25.2	27.8	MHz	
	"High" time	Tch	18	-	-	ns	
	"Low" time	Tcl	18	-	-	ns	
Data	Setup time	Tds	5	-	-	ns	
	Hold time	Tdh	5	-	-	ns	
Hsync	Period	TH	30.00	31.78		μ s	
			770	800	900	clock	
	Pulse width	THp	2	96	200	clock	
Vsync	Period	TV	515	525	560	line	
	Frequency	1/TV	50	60	-	Hz	[Note7-1]
	Pulse width	TVp	1	-	34	line	
Horizontal display period		THd	640	640	640	clock	
Phase difference between Hsync and clock		THc	$(Tc/2) - 10$	-	$(Tc/2) + 10$	ns	
Phase difference between Hsync and Vsync		TVh	-2	-	2	clock	
Vertical display period		TVd	480	480	480	line	

Note7-1) In case of lower frequency, the deterioration of display quality, flicker etc., may occur.

Please use this module in more than 50Hz.(1/TV)

7.2 Display Position in horizontal direction

Display position in horizontal direction is designated by rising timing of ENAB signal.

Parameter		Symbol	MIN	TYP	MAX	Unit	Note
ENAB signal	Setup time	Tes	7	-	$(Tc/2) - 5$	ns	
	Pulse width	Tep	2	640	640	clock	
Phase difference between Hsync and ENAB signal		THE	44	-	TH-664	clock	

When ENAB is fixed to "Low", the horizontal display will start from the clock C100 (clock) as shown in Fig.2. When the phase difference is not greater than 100 clock, hold ENAB terminal in "High" state for more than $(100 - THE)$, otherwise display will start from C100 (clock).

7.3 Display position in vertical direction

Display start position in vertical direction is fixed to the 34th line.

The ENAB signal does not relate to Vertical display position.

7.4 Input signal and display on the screen

Display position of input data

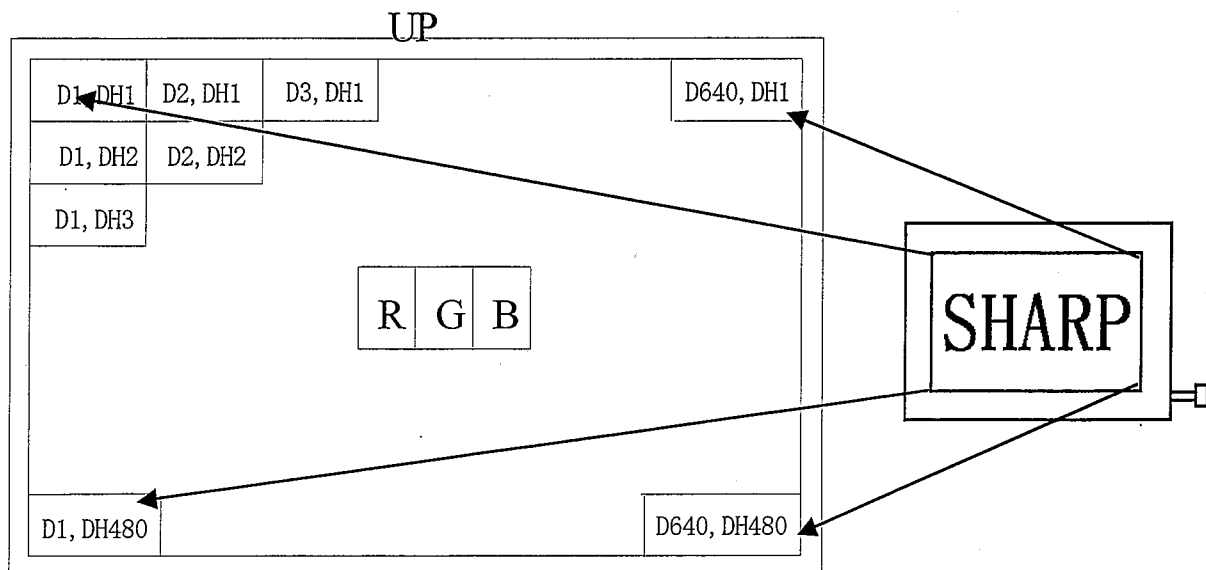

8 Input Signals, Basic Display Colors and Gray Scale of Each Color

	Colors & Gray scale	Data signal																		
		Gray Scale	R0	R1	R2	R3	R4	R5	G0	G1	G2	G3	G4	G5	B0	B1	B2	B3	B4	B5
Basic Color	Black	-	0	0	0	0	0	0	0	0	0	0	0	0	0	0	0	0	0	0
	Blue	-	0	0	0	0	0	0	0	0	0	0	0	0	1	1	1	1	1	1
	Green	-	0	0	0	0	0	0	1	1	1	1	1	1	0	0	0	0	0	0
	Cyan	-	0	0	0	0	0	0	1	1	1	1	1	1	1	1	1	1	1	1
	Red	-	1	1	1	1	1	1	0	0	0	0	0	0	0	0	0	0	0	0
	Magenta	-	1	1	1	1	1	1	0	0	0	0	0	0	1	1	1	1	1	1
	Yellow	-	1	1	1	1	1	1	1	1	1	1	1	1	0	0	0	0	0	0
	White	-	1	1	1	1	1	1	1	1	1	1	1	1	1	1	1	1	1	1
Gray Scale of Red	Black	GS0	0	0	0	0	0	0	0	0	0	0	0	0	0	0	0	0	0	0
	↑	GS1	1	0	0	0	0	0	0	0	0	0	0	0	0	0	0	0	0	0
	Darker	GS2	0	1	0	0	0	0	0	0	0	0	0	0	0	0	0	0	0	0
	↑	↓				↓				↓							↓			
	↓	↓				↓				↓							↓			
	Brighter	GS61	1	0	1	1	1	1	0	0	0	0	0	0	0	0	0	0	0	0
	↓	GS62	0	1	1	1	1	1	0	0	0	0	0	0	0	0	0	0	0	0
Red	GS63	1	1	1	1	1	1	0	0	0	0	0	0	0	0	0	0	0	0	
Gray Scale of Green	Black	GS0	0	0	0	0	0	0	0	0	0	0	0	0	0	0	0	0	0	0
	↑	GS1	0	0	0	0	0	0	1	0	0	0	0	0	0	0	0	0	0	0
	Darker	GS2	0	0	0	0	0	0	0	1	0	0	0	0	0	0	0	0	0	0
	↑	↓				↓				↓							↓			
	↓	↓				↓				↓							↓			
	Brighter	GS61	0	0	0	0	0	0	1	0	1	1	1	1	0	0	0	0	0	0
	↓	GS62	0	0	0	0	0	0	0	1	1	1	1	1	0	0	0	0	0	0
Green	GS63	0	0	0	0	0	0	1	1	1	1	1	1	0	0	0	0	0	0	
Gray Scale of Blue	Black	GS0	0	0	0	0	0	0	0	0	0	0	0	0	0	0	0	0	0	0
	↑	GS1	0	0	0	0	0	0	0	0	0	0	0	0	1	0	0	0	0	0
	Darker	GS2	0	0	0	0	0	0	0	0	0	0	0	0	0	1	0	0	0	0
	↑	↓				↓				↓							↓			
	↓	↓				↓				↓							↓			
	Brighter	GS61	0	0	0	0	0	0	0	0	0	0	0	0	1	0	1	1	1	1
	↓	GS62	0	0	0	0	0	0	0	0	0	0	0	0	0	1	1	1	1	1
Blue	GS63	0	0	0	0	0	0	0	0	0	0	0	0	1	1	1	1	1	1	

0: Low level voltage, 1: High level voltage

Each basic color can be displayed in 64 gray scales from 6 bit data signals. According to the combination of total 18 bit data signals, the 262,144-color display can be achieved on the screen.

9 Optical Specification

Ta=25°C, Vcc=+3.3V

Parameter		Symbol	Condition	Min.	Typ.	Max.	Unit	Remark
Viewing angle Range	Horizontal	$\theta 21, \theta 22$	CR \geq 5	60	70	-	° (Deg.)	[Note9-1,4]
	Vertical	$\theta 11$		35	40	-	° (Deg.)	
		$\theta 12$		55	70	-	° (Deg.)	
Contrast ratio		CR max	Best viewing angle	250	350	-	-	[Note9-2]
Response time	Rise	Tr	$\theta = 0^\circ$	-	8	20	ms	[Note9-3]
	Fall	Td		-	21	40	ms	
Chromaticity of white		x	IL=10mArms	0.263	0.313	0.363	-	[Note9-4]
		y		0.279	0.329	0.379	-	
Luminance		Y		260	350	-	cd/m ²	

Lamp test in the module is made with the inverter type HIU-359A-S2(18pF) at 50kHz

The optical specifications are measured 30 minute after turning lamp on and in a dark room or equivalent condition, according to the method shown in Fig.9-1, 2 below.

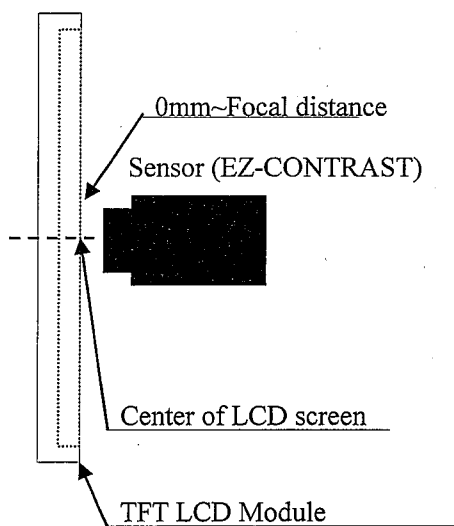

Fig.9-1 Measuring setup for
Viewing angle and Contrast
(BM-7 is used for contrast.)

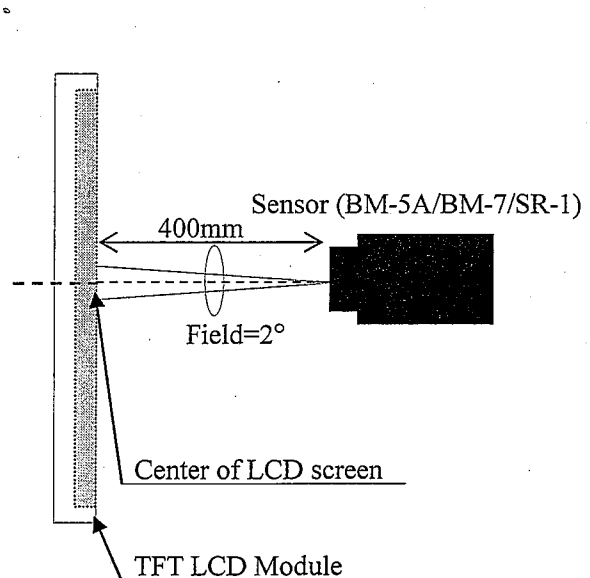
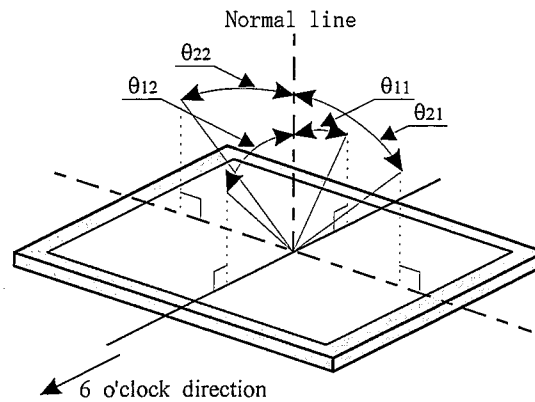

Fig.9-2 Measuring setup for
Luminance, Chromaticity
and Response time
(BM-7 is used for Luminance, SR-1 is for response)

[Note9-1] Definitions of viewing angle range:



[Note9-2] Definition of contrast ratio:

The contrast ratio is defined as the following.

$$\text{Contrast Ratio (CR)} = \frac{\text{Luminance (brightness) with all pixels white}}{\text{Luminance (brightness) with all pixels black}}$$

[Note9-3] Definition of response time:

The response time is defined as the following figure and shall be measured by switching the input signal between "black" and "white" alternatively.

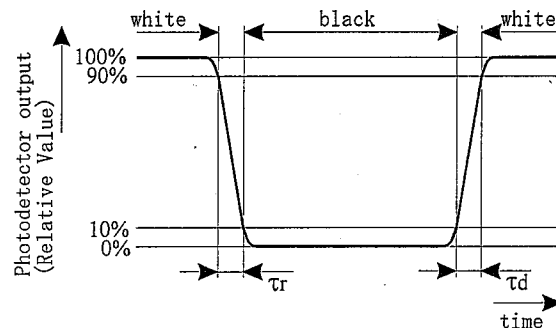

[Note9-4] This parameter should be measured at the center of the screen and 30 minutes after turn-on.

Inverter frequency: 50 kHz

The characteristics are measured when the driver circuit is not powered.

10 Display Qualities

Please refer to the Outgoing Inspection Standard.

11 Handling Instruction

11.1 Assembling the module

- 1)
 - In this module, the contact of the front shield case and the back is not always contact electrically each other.
 - The front shield case and the back touches at the point "A" hole perfectly, when this module is mounted to the unit of customer.
 - Therefore, please fix the mounting hole in the same plane in the case of the module installation, so that stress such as bow and crook may not be added to the module.
 - To ensure the electric contact of the front shield case and the back, please fasten the mounting hole "A" of figure.1 surely, when you mount this module to the customer's set.
- 2) Connection/disconnection of the module's input connector shall be made while power is off.
- 3) Make sure to connect module's metal shield case to GND of inverter circuit.
If its connection is not made perfectly, some of the following problems may occur.
 - a) Increase of noise caused by backlight
 - b) Unstable output from inverter circuit
 - c) Possibly over-heat in some section

11.2 Instruction for assembling

Since the front polarizer is easily damaged, pay attention to avoid rubbing with something hard or sharp. A protective film "Laminator" is attached on the module screen to avoid scratch and/or dust.

You are recommended remove the "Laminator" just before you embed the module into your products, paying attention to avoid electrostatic damage as followings.

A) Work Environment

Since removing laminator may causes electrostatic charge that tends to attract dust, the following work environment would be desired.

- a) Floor: Conductive treatment having $1M\Omega$ resistance onto floor's tile
- b) The room free from dust coming from outdoor environment, and put an adhesive mat at entrances
- c) Humidity from 50% to 70% and temperature from $15^{\circ}C$ to $27^{\circ}C$ are desirable.
- d) Worker should ware conductive shoes, conductive fatigue, conductive glove and earth wrist band.

B) Instruction for working

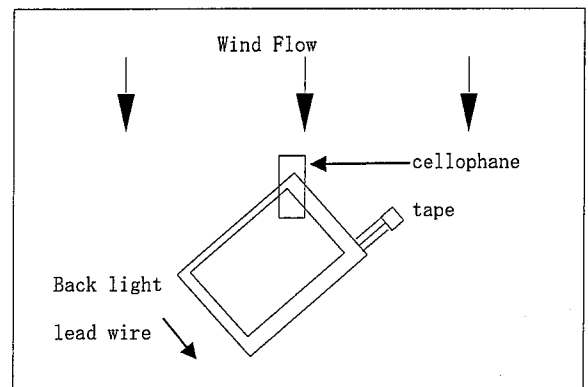
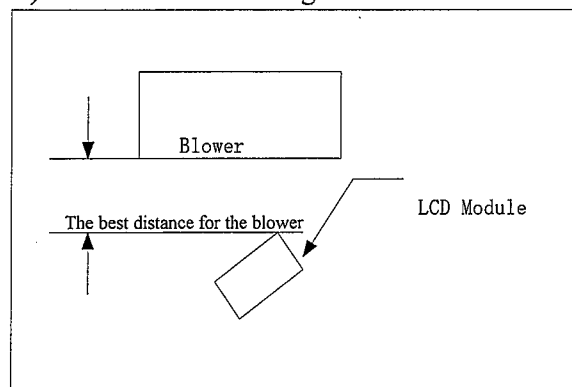

- a) Wind direction of an electrostatic discharging blower should slightly downward to properly blow the module. The distance between the blower and the module should be the best distance for the blower. Also, pay attention to the direction of the module.

- b) To prevent polarizer from scratching, adhesive tape (cellophane tape) should be stuck at the part of laminator sheet, which is closed to blower. [See the above]
- c) Pull slowly adhesive tape to peel the laminator off, with spending more than 5 second.
- d) The module without laminator should be moved to the next process to prevent dust.
- e) How to eliminate dust on polarizer.

Blow dust away by N₂ blower having measures of electrostatics

Since the front polarizer is easily damaged, wiping dust off is not adequate.

If the polarizer is soiled, it is suggested to peel dust off by using adhesive surface of adhesive tape.

When the metal section [shield case or shield back case] is soiled, wipe it off with dry and soft cloth. If not so easy, breathe upon it then wipe off. If the water droplet or fat is left for long term, it may cause stain or tarnish, it should be wipe off immediately.

Since TFT-LCD panel is made of glass substrate, dropping the panel or banging it against hard objects may cause cracking or fragmentation.

Since CMOS LSIs are incorporated in this module, please pay special care to electrostatic while handling it, and earth human body.

11.3 Caution in product design

The notes and cautions below should be followed when product is designed with this module.

The module should be protected with cover to prevent salt content and/or water droplet.

Take enough shielding countermeasure not to interfere to peripheral electronic device.

11.4 Others

The LCD has the nature that its performance is degradation by ultra-violet light. Don't leave the LCD module in direct sunlight or strong ultra violet ray.

If stored at the temperatures lower than the rated storage temperature, the LC may freeze and it may cause LCD panel damage. If storage temperature exceeds the specified rating, the molecular orientation of the LC may change to that of a liquid, and they may not revert to their original state. Store the module in normal room temperature.

The inductive loss caused by routing of lamp lead wire, which is closed to conductive section, may require the kick-off voltage greater than specified kick-off voltage.

The liquid crystal may leak out when the LCD is broken. If the liquid crystal drip into the eyes or mouth washes it out immediately.

The caution to other ordinal electronic component should be followed also.

Don't use or store the module in corrosive gas environment.

Don't use or store the module in condensation environment.

12 Packing Form

12.1 Fig.3 shows packaging form.

12.2 Carton stock conditions

- a) Maximum number of Carton being stuck: 8
- b) Maximum number of product contained: 20 Unit
- c) Carton size: 495mm (W) x 329mm (H) x 218mm (D)
- d) Total mass (for 20Unit): Approximately 7kg
- e) Carton stock environment:
 - 1) Temperature: 0 ~ 40°C
 - 2) Humidity: Up to 60%RH
 - 3) Ambiance: No gases bite into electronic components and wiring materials
 - 4) Period: Approximately 3month
 - 5) Unpacking: To prevent LCD module from damaging by ESD, unpack the module with effective measure after controlling humidity 50%RH or more.

13 Marking of product name

13.1 Serial No. indication

Serial No. is indicated by labeling. The location is given in Fig.1 Outline dimension.

Indicated contents:

LQ064V3DG01	XXXXXXXXXX
--------------------	-------------------

Model name

Serial No.

Serial No. contents 1st digit:	last digit of produced year (ex. 2004 → "4")
2nd digit:	Produced month 1, 2, 3 ~ 9, X, Y, Z
3rd ~ 8th digit:	Sequential number 000001 ~
9th digit:	Interoffice control code

14 Miscellaneous

- a) Variable resistor has been set optimally before shipment, so do not change any adjusted value. If adjusted value is changed, the specification may be not satisfied.
- b) Don't disassemble this module, it may cause malfunction.
- c) Image retention may occur when the fixed image is display for long time.

15 Reliability Test Items

Note: The condition of temperature is the operation temperature given in Absolute maximum rating.

No.	Test parameter	Conditions
1	High temperature storage test	Leaves the module at Ta=80°C for 240h
2	Low temperature storage test	Leaves the module at Ta=-30°C for 240h
3	High temperature & high humidity operation test	Operates the module at Ta=40°C; 90~95%RH for 240h (No condensation)
4	High temperature operation test	Operates the module with +80°C at panel surface for 240h
5	Low temperature operation test	Operates the module at Ta=-30°C for 240h [Note] Lamp life time is excluded. Kick-off voltage (Ta=-30°C) is reference.
6	Strength against ESD	±200V·200pF [0 Ω] one time for each terminal
7	Shock test (non- operating)	Max. acceleration : 980m/s ² Pulse width : 6ms, half sine wave Direction : ±X,±Y,±Z once for each direction.
8	Vibration test (non- operating)	Frequency : 10~57Hz/Vibration width (one side):0.15mm : 58~500Hz/ acceleration:19.6m/s ² Sweep time : 6 minutes Test period : 3 hours (1 hour for each direction of X,Y,Z)
9	Thermal shock test	-30°C ~ +80°C /50 cycle [0.5h] [0.5h]

[Result Evaluation Criteria]

Under the display quality test conditions with normal operation state, these shall be no change which may affect practical display function.

[Note] The directions of X, Y, Z are defined as below:

SHARP

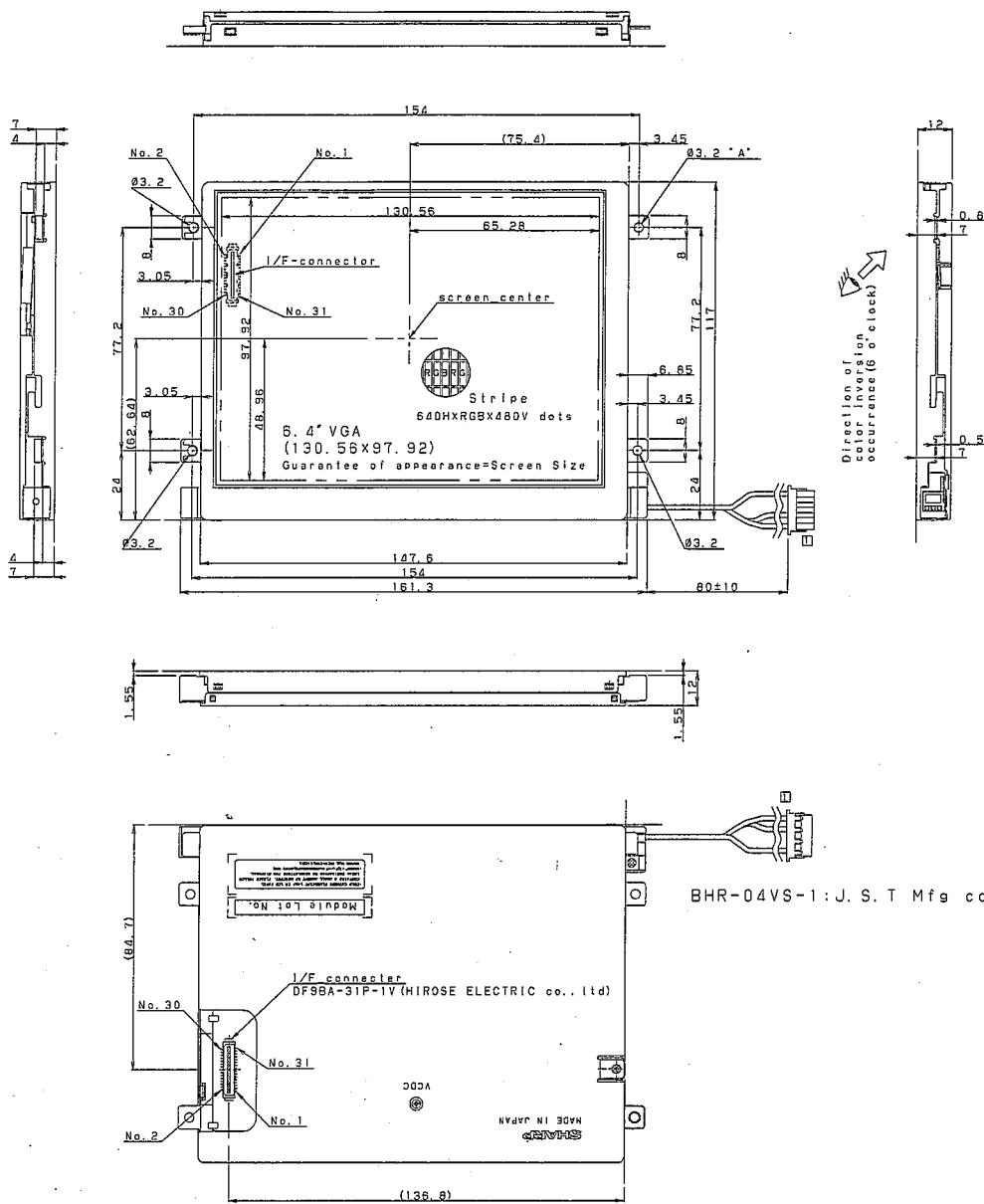

- General tolerance is ± 0.5 .
- Take care in set design to hide the scratches and bubbles appeared on the polarizer or other frame area which is located outside of active area.
- To ensure the electric contact of the front shield case and the back, please fasten the mounting hole "A" of figure.1 surely, when you mount this module to the customer's set.

unit:mm	Please do not copy this material and do not disclose this to third party.		△		
DATE	2004.11.17	SCALE	△		
MODEL	LQ064V3DG01	free	△	No.	DATE REVISION
DRAWING NO	LCM-04079	size A2	△	ENGINEERING DEPARTMENT I MOBILE LCD DESIGN CENTER I MOBILE LIQUID CRYSTAL DISPLAY GROUP SHARP CORP.	

Fig 1 DIMENSIONS OF THE MODULE

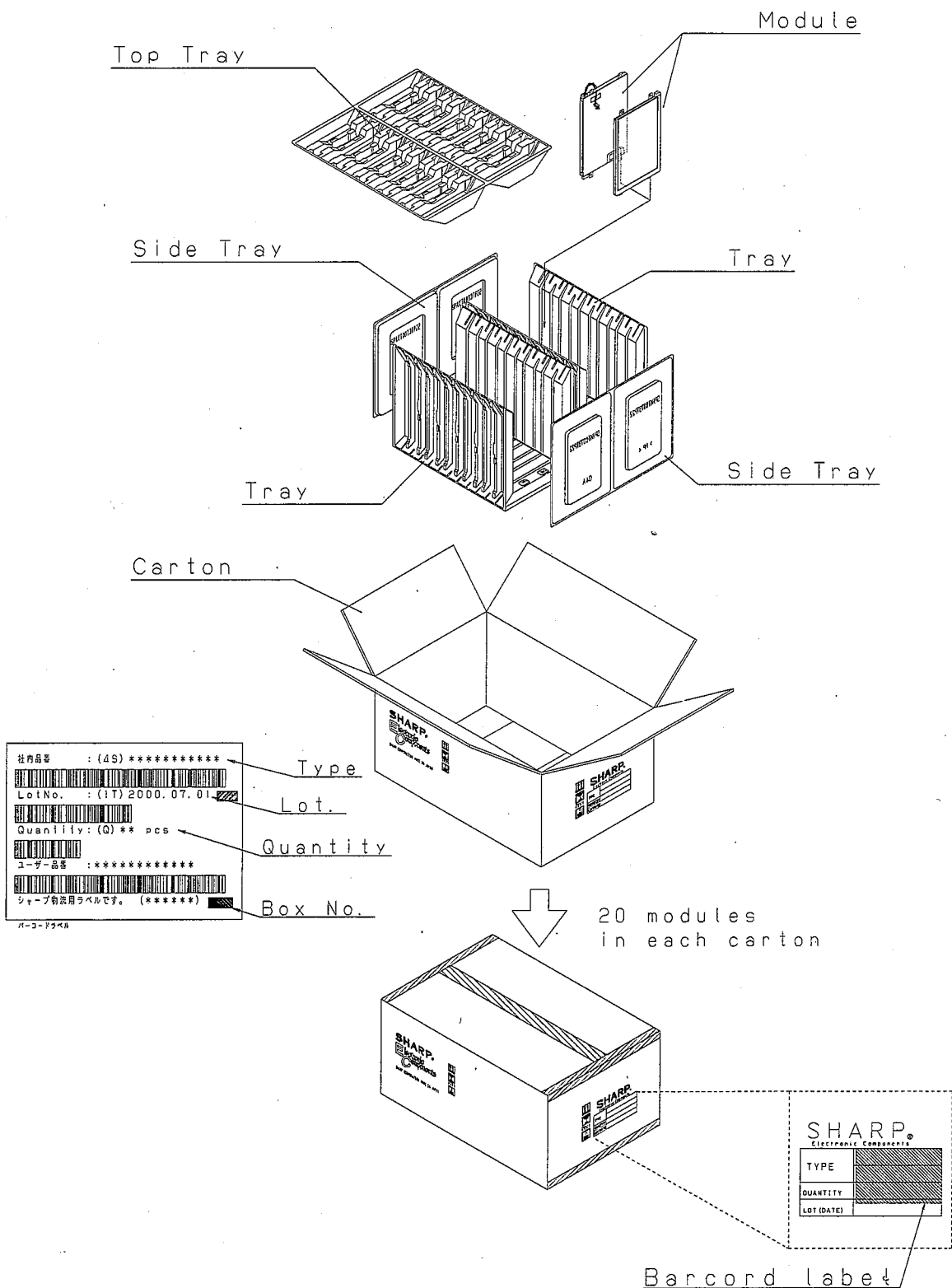

Fig 3 PACKING FORM

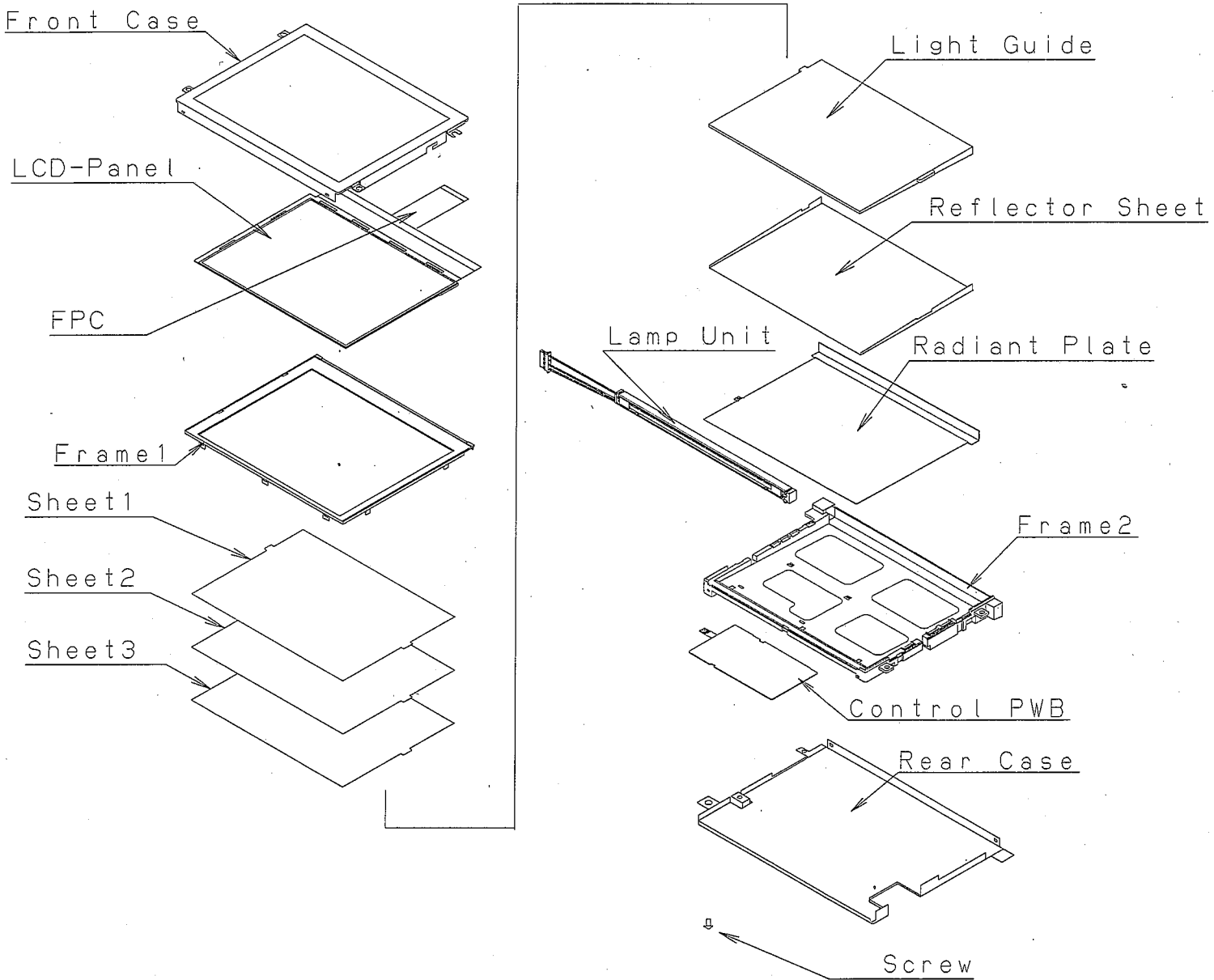

Fig 4 MODULE STRUCTURE

SPECIFICATIONS ARE SUBJECT TO CHANGE WITHOUT NOTICE.

Suggested applications (if any) are for standard use; See Important Restrictions for limitations on special applications. See Limited Warranty for SHARP's product warranty. The Limited Warranty is in lieu, and exclusive of, all other warranties, express or implied. ALL EXPRESS AND IMPLIED WARRANTIES, INCLUDING THE WARRANTIES OF MERCHANTABILITY, FITNESS FOR USE AND FITNESS FOR A PARTICULAR PURPOSE, ARE SPECIFICALLY EXCLUDED. In no event will SHARP be liable, or in any way responsible, for any incidental or consequential economic or property damage.

SHARP®

NORTH AMERICA

SHARP Microelectronics of the Americas
5700 NW Pacific Rim Blvd.
Camas, WA 98607, U.S.A.
Phone: (1) 360-834-2500
Fax: (1) 360-834-8903
Fast Info: (1) 800-833-9437
www.sharpsma.com

EUROPE

SHARP Microelectronics Europe
Division of Sharp Electronics (Europe) GmbH
Sonninstrasse 3
20097 Hamburg, Germany
Phone: (49) 40-2376-2286
Fax: (49) 40-2376-2232
www.sharpsme.com

JAPAN

SHARP Corporation
Electronic Components & Devices
22-22 Nagaike-cho, Abeno-Ku
Osaka 545-8522, Japan
Phone: (81) 6-6621-1221
Fax: (81) 6117-725300/6117-725301
www.sharp-world.com

TAIWAN

SHARP Electronic Components
(Taiwan) Corporation
8F-A, No. 16, Sec. 4, Nanking E. Rd.
Taipei, Taiwan, Republic of China
Phone: (886) 2-2577-7341
Fax: (886) 2-2577-7326/2-2577-7328

SINGAPORE

SHARP Electronics (Singapore) PTE., Ltd.
438A, Alexandra Road, #05-01/02
Alexandra Technopark,
Singapore 119967
Phone: (65) 271-3566
Fax: (65) 271-3855

KOREA

SHARP Electronic Components
(Korea) Corporation
RM 501 Geosung B/D, 541
Dohwa-dong, Mapo-ku
Seoul 121-701, Korea
Phone: (82) 2-711-5813 ~ 8
Fax: (82) 2-711-5819

CHINA

SHARP Microelectronics of China
(Shanghai) Co., Ltd.
28 Xin Jin Qiao Road King Tower 16F
Pudong Shanghai, 201206 P.R. China
Phone: (86) 21-5854-7710/21-5834-6056
Fax: (86) 21-5854-4340/21-5834-6057

Head Office:

No. 360, Bashen Road,
Xin Development Bldg. 22
Waigaoqiao Free Trade Zone Shanghai
200131 P.R. China
Email: smc@china.global.sharp.co.jp

HONG KONG

SHARP-ROXY (Hong Kong) Ltd.
3rd Business Division,
17/F, Admiralty Centre, Tower 1
18 Harcourt Road, Hong Kong
Phone: (852) 28229311
Fax: (852) 28660779
www.sharp.com.hk

Shenzhen Representative Office:

Room 13B1, Tower C,
Electronics Science & Technology Building
Shen Nan Zhong Road
Shenzhen, P.R. China
Phone: (86) 755-3273731
Fax: (86) 755-3273735