

Revision History

Date	Rev No	Sheet (New)	Item	Old	New	Reason

Caution and Handling Precaution

For your end users' safety, it is strongly advised that the items with "* " should be included in the instruction manual of the system which may be issued by your organization.

Toshiba Matsushita Display Technology always endeavor to maintain sufficient quality of the LCD panel in process of designing and manufacturing, however, to avoid causing extended damages such as accidents resulting in injury or death, fire accidents, or social damages if the LCD panel fails, please adopt safe design as a whole set, by adopting redundant design, taking measure in set design to prevent fire-spreading, over-current, or incorrect operation, etc.

For Safety



Warning

1) SPECIAL PURPOSES

- a) Toshiba Matsushita Display Technology's Standard LCD modules have not been customized for operation in extreme environments or for use in applications where performance failures could be life-threatening or otherwise catastrophic.
- b) Since they have not been designed for operation in extreme environments, they must never be used in devices that will be exposed to abnormally high levels of vibration or shock which exceed Toshiba Matsushita Display Technology's specification limits.
- c) In addition, since Toshiba Matsushita Display Technology's Standard LCD modules have not been designed for use in applications where performance failures could be life-threatening or catastrophic. They must never be installed in aircraft navigation control systems (such as, but not limited to Traffic Collision Avoidance System and Air Traffic Indicator), in military defense or weapons systems, in critical industrial process-control systems (e.g., those involved in the production of nuclear energy), or in critical medical device or patient life-support systems.

2) ELECTRIC SHOCK

DISCONNECT POWER SUPPLY before handling LCD modules. In order to prevent electric shock, DO NOT TOUCH the electrode part, cables, connectors, and the fluorescent lamp's (hereinafter called "FL") circuit part of a module in which FL tubes are built in as a light source of a backlight or a front light. High voltage is supplied to these parts while power supply is turned on.

3) FL CABLE CONNECTION

Make sure to insert the module FL connector to the inverter connector in correct position and correct polarity. If incorrect, this may cause smoke or burn of electrical parts by high voltage of FL circuit. If there is a possibility that the connector has been inserted incorrectly, re-insert the connector only after you confirm the module and FL power is completely off. When disconnecting the connector, do not pull on the cable.

DO NOT USE the mating FL connector which Toshiba Matsushita Display Technology does not specify. Otherwise, Toshiba Matsushita Display Technology shall not be liable for any damages caused by the connector.



Caution

1-1 CAUTION

1) *DISASSEMBLING OR MODIFICATION

DO NOT DISASSEMBLE OR MODIFY the modules.

Sensitive parts inside LCD module may be damaged, and dusts or scratches may mar the displays. Toshiba Matsushita Display Technology does not warrant the modules, if customer disassembled or modified them.

2) *BREAKAGE OF LCD PANEL

DO NOT INGEST liquid crystal material, DO NOT INHALE this material, and DO NOT PERMIT this material to contact the skin, if glass of LCD panel is broken.

If liquid crystal material contacts the skin, mouth or clothing, take the following actions immediately.

Toshiba Matsushita Display Technology Co., Ltd.

Date:2006-11-30

New No. LTD121EXVV-11

Date: - -

Old No.

In case contact to the eye or mouth, rinse with large amount of running water for more than 15 minutes. In case contact to the skin or clothing, wipe it off immediately and wash with soap and large amount of running water for more than 15 minutes. The skin or clothing may be damaged if liquid crystal material is left adhered.

In case ingestion, rinse out the mouth well with water. After spewing up by drinking large amount of water, get medical treatment.

3) *GLASS OF LCD PANEL

BE CAREFUL WITH CHIPS OF GLASS that may cause injuring fingers or skin, when the glass is broken.

Since FL is also made of glass, when FL is built in, handle it with due caution as well.

4) ABSOLUTE MAXIMUM RATINGS

DO NOT EXCEED the absolute maximum rating values under the worst probable conditions caused by the supply voltage variation, input voltage variation, variation in parts' constants, environmental temperature, etc., otherwise LCD module may be damaged.

5) RECOMMENDED OPERATION CONDITIONS

Don't exceed "the recommended operation conditions" in this specification. (The LCD panel should be used within "the recommended operation conditions".)

The performance and quality of the LCD panel are warranted only when the LCD panel is used within "the recommended operation conditions". Toshiba Matsushita Display Technology never warrants the performance and quality of the LCD panel when you use the LCD panel over "the recommended operation conditions", although within "the absolute maximum rating".

To use the LCD panel over "the recommended operation conditions" may have bad influence on the characteristics and reliability of the LCD panel and may shorten the life of the LCD panel.

Therefore, when designing the whole set, not to be over "the recommended operation conditions", you should fully take care of supply voltage change, characteristic of connection parts, surge of input-and-output line, and surrounding temperature.

6) POWER PROTECTION CIRCUIT

Employ protection circuit for power supply, whenever the specification specifies it.

A suitable protection circuit should be applied, based on each system design.

DO NOT MODIFY the fuse used in the module. It may cause overheat and/or burning if dusts or metal particles are on the PCBs in the LCD module.

7) DISPOSAL

Always comply all applicable environmental regulations, when disposing of LCD module.

8) EDGES OF PARTS

Be careful with handling the metal frame (bezel) of a module. Even though burr disposal treatment is performed, it may cause injuring. Be careful with edges of glass parts and touch panel identically. For designing the system, give special consideration that the wiring and parts do not touch those edges.

9) *LUMINANCE DECREASE OF FL

When FL becomes extremely dark and its color changes from white to pink, stop the use of the module immediately. FL, at the end of its life with its discharge color turns into pink as the characteristics of FL, may adversely affect the module at the end part of FL due to temperature rising caused by depletion of the mercury which is contained in FL tube, or may have a possibility of breakage.

10) High Temperature on FL

FL tubes that become a backlight source are built into a top and bottom side of LCD module.

Please remind that the portion such as the surface of LCD module, the metal frame portion, and FL unit cover on the rear side become high temperature during lighting and right after turning off the FL.

In the case you have to contact these portion, surely turn off the power supply to the LCD module first, and being careful with ELD prevention (see 3-2), use hand glove that protects hands (skin) from heat or contact after the temperature at the metal portion falls to the room temperature level.

For Designing the System

2-1 DESIGNING ENCLOSURE

1) MECHANICAL DIMENSIONS

Refer to the individual specification for LCD module's mechanical dimensions.

2) MOUNTING HOLES

LCD module should be assembled to the system by using all mounting holes specified in the individual specification with the specified screws.

In addition, some modules may not be necessary to use all the mounting holes. Make comprehensive judgments on the entire system.

3) *BENDING / TWISTING

Make sure to design the enclosure that bending/twisting forces are not applied to LCD module during and after the installation into the system.

4) DESIGN OF LCD MODULE REAR SURFACE

Design to not touch object to oblique lines area of drawing mentioned below.

This LCD module uses light guide. If light guide is pushed, there is danger of appearance of white spot or black spot.

And if circuit board is pushed, there is danger of damage.

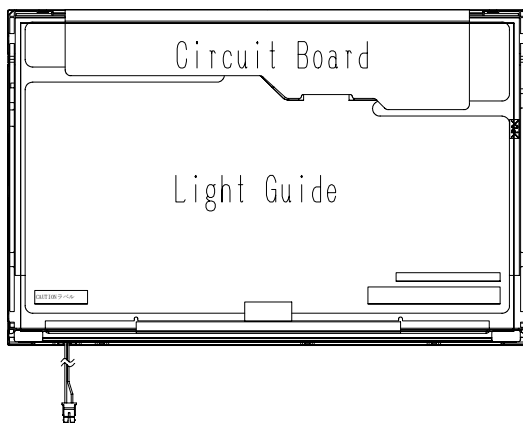

5) GASES FROM SETTING MATERIAL

Some plastic materials and shock absorbing materials (rubber) used in the system may generate gases that may cause the deterioration of the polarizer laminated on LCD's panel or internal parts of the module. Prior confirmation is required.

6) GASES FROM PACKAGING MATERIAL

Some materials used for packaging (for which sulfuric acid is used in the recycling process) generate gases that may cause the deterioration of the polarizer laminated on LCD's panel or internal parts of the module. Prior confirmation is required.

2-2 DESIGNING POWER SUPPLIES AND INPUT SIGNALS TO LCD MODULE

1) CAPACITY OF POWER SUPPLY

Be sure that power supply output from the system should be limited to higher values than listed shown below. (For example Quick Arcing Fuse with listed ratings can be used.)

It is because this LCD module explained in this specification has a current limiter, with such function at power input line(s). But it may be some possibility of overheat and/or burning of LCD module and its peripheral devices before current limiter of the module when open-short test of the module is performed by using power supply smaller than following recommended value.

Power Supply	Recommended maximum output current of power supply	Recommended Fuse Rating (in case of using fuse for current limiter)	Built-in Fuse Rating (for reference)
V _{DD}	4.0 A	0.5-3.0 A	1.5 A

Refer to individual specification for details for capacity of power supply, and apply some protection circuit including fuses for power supply lines.

2) SEQUENCE OF POWER SUPPLIES AND INPUT SIGNALS

Power-supply lines should be designed as follows.

Power supplies should always be turned on before the input signals are supplied to LCD module, and the input signals should be disconnected before power supplies are turned off.

If this sequence is not followed, it may cause mis-operation of the panel.

Refer to "[2.4.2 Sequence of Power Supplies and Signals](#)" for the detailed specification.

In addition, refer to individual specifications for unused terminals.

3) FL CABLE CONNECTION

Make sure to connect correctly high-voltage wire and low-voltage wire between FL tube and inverter unit.

If high-voltage wire and low-voltage wire are connected incorrectly, it may cause insufficient brightness or unstable operation of FL, and smoke or burn of the parts.

4) PREVENTION OF IMAGE STICKING

Design the system not to display same pattern for a long time in order to prevent image sticking on the panel. Note that incorrect sequence of power supplies and input signals may cause the sticking on the panel, too.

5) GROUNDING OF METAL FRAME

Grounding of metal frame of LCD module is generally effective to prevent radiation interference from the system design.

However, the necessity of grounding, or effective grounding method should be dependent on each system design.

2-3 DESIGNING FOR BETTER VISIBILITY

1) PANEL ANGLE

Visibility of LCD module deeply depends on the viewing directions. The position and the angle of LCD module in the system should be designed so that the best visibility can be obtained at the actual usage.

2) WINDOW OPENING

Dimensions of window opening of the system's enclosure should be designed as smaller than "Viewing Area" and larger than "Active Area" specified in individual specification in order to obtain better appearance.

3) PROTECTIVE COVER

In case of severe environmental condition like outdoor usage, a proper transparent protective cover(lens) over LCD module is recommended to apply in order to prevent scratches, and invasion of dust, water, etc., from the system's window onto LCD module.

Ultra-violet ray cut filter is recommended to apply onto LCD module for outdoor operation. Strong ultra-violet ray may cause damage the panel. However, in that case, transmittance-luminance will decrease. Careful selection of material is required.

2-4 DESIGNING FL POWER SUPPLY CIRCUIT

Input FL starting voltage(V_{SFL}) should be longer than two seconds. If it were not, it may cause unstable operation of FL.

Inverter should be design to stop output when the inverter is no-load to FL tubes (due to breakage of FL, etc.) to prevent high-voltage generation.

When high voltage is applied to FL continuously without normal operation of FL (due to output leakage within FL wiring circuit, etc.) it may cause smoke or burn. To prevent excess current, design the inverter with a protection circuit such as a current limiter (excess current detection) to stop inverter output.

Please adjust inverter circuit parameters, such as capacitor, resistor, to assure the display quality is maintained.

There is a possibility that flicker is observed by the interference of LCD operating signal timing and FL driving condition (especially driving frequency).

DO NOT APPLY high voltage to "Low Voltage" side of the FL.

For example, DO NOT USE a floating inverter which gives high voltage to "Low Voltage" side. it may cause insufficient brightness or unstable operation of FL, and smoke or burn of the parts.

For Installation in Assembly**3-1 CARRYING**

Hold metal frame (bezel) when you carry LCD module. Don't hold FL cable.

3-2 ESD (ELECTRO-STATIC DISCHARGE) PREVENTION

The C-MOS LSIs used in LCD module is very sensitive to ESD. The following caution should be taken when installing LCD module to an enclosure of the system in order to prevent damage of C-MOS LSIs used in LCD module.

1) HUMIDITY

Ambient humidity of working area is recommended to be higher than 50%RH in order to avoid ESD.

2) GROUNDING

2-1) Grounded electro-conductive mats are recommended to be covered on the floor of working area and surface of working benches.

2-2) The grounding should be done through a resistor of 0.5-1M ohms in order to prevent spark of ESD.

2-3) Person handling LCD modules should be grounded with such as wrist band.

2-4) Tools like screw drivers and working benches should be grounded.

3) IONIZER

Using ionizer (an antistatic blower) is recommended at working area in order to reduce electro-static voltage.

4) REMOVING PROTECTION FILM

When removing protection film from LCD panel, peel off the film slowly (more than three seconds) from the edge of the panel with round-ended tweezers or adhesive tape while blowing with ionizer toward the peeling face to minimize ESD which may damage electrical circuit.

5) Be careful with touching metal portion of testing instruments in order to prevent unnecessary ESD.

6) Do not touch the electrode area of PCB and electrical parts like LSI, capacitor, connector pin, etc.

3-3 DUST AND STAIN PREVENTION**1) WORKING AREA**

Reduce dust level in working area. Especially the level of metal particle should be decreased, otherwise electrical circuit in LCD module may be damaged due to short circuit by metal particles.

2) PROTECTION FILM

LCD module may be shipped with "protection film" on LCD panel in order to prevent from scratches and dust.

It is recommended to remove the film at later process of assembling.

3) FINGER PRINT

Use finger stalls or soft and dust-free gloves in order to keep clean appearance of LCD module when handled for incoming inspection and assembly.

4) *WIPING OFF DUST ON THE PANEL

When LCD panel becomes dirty, wipe the panel surface off softly with absorbent cotton or another soft cloth.

If necessary, breathe upon the panel surface and then wipe off immediately and softly again.

If the dirt can not be wiped off, follow the instructions described in individual specification.

Be careful not to spill organic solvents into the inside of LCD module. The polarizer laminated to LCD panel and adhesives may be invaded by the organic solvents, so do not use any organic solvents for wiping off LCD panel. Driver IC and PCB area used inside LCD module may be damaged by the solvents.

5) ADHESIVE ON LCD PANEL

Be careful not to attach adhesive, grease, etc., on LCD panel, because it is difficult to remove them without any damages on LCD panel.

6) *WATER SPOTS ON THE PANEL

Avoid the dewing or water condensation.

Wipe off a spot or spots of water or mist on LCD panel softly with absorbent cotton or another cloth as soon as possible if happened, otherwise discoloration or stain may be caused. If water invades into LCD module, it may cause LCD module damages.

7) Gas

Do not expose LCD module to the gas (which is not normally contained in the atmosphere), it may cause mis-operation or defects.

3-4 BENDING / TWISTING OF LCD MODULE DURING ASSEMBLY

1) INSTALLING LCD MODULE TO THE ENCLOSURE

Do not bend or twist LCD module even momentary when LCD module is installed into an enclosure of the system.

Bending or twisting LCD module may cause its damages.

2) FASTENING SCREWS

Fasten screws for mounting holes uniformly, otherwise bending / twisting force may be applied to LCD module.

3) INTERFACE / FL CABLES

Do not fasten screws, with catching interface cables or FL cables between LCD module and the enclosure.

This may cause bending of LCD module, or become the cause of a failure by damaging cables.

3-5 MECHANICAL FORCES

1) *STRONG MECHANICAL SHOCK

Refrain from strong mechanical shock like dropping from the working bench or knocking against hard object.

These may cause panel crack, damage of FL or other miss-operation.

2) *EXCESSIVE FORCE

Refrain from excessive force like pushing the surface of LCD panel and LCD module. This may cause scratches or breakage of the panel, or a failure of the module.

3) *PRESSURE ON THE PANEL

Do not put heavy object such as tools, books, etc., and do not pile up LCD modules.

Be careful not to touch surface of the polarizer laminated to the panel with any hard and sharp object. The polarizer is so soft that it can be easily scratched, even the protect film covers it.

4) *PRESSURE ON REAR SIDE

Don't push at oblique lines of drawing mentioned below.

This LCD module uses light guide. If light guide is pushed, there is danger of appearance of white spot or black spot.

And if circuit board is pushed, there is danger of damage.

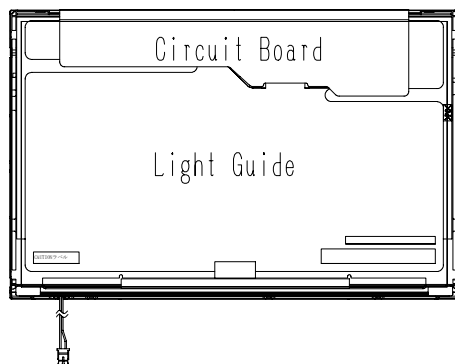

5) CONNECTORS

When inserting or disconnecting the connectors to LCD module, be sure not to apply force against PCB nor connecting cables, otherwise internal connection of PCB and TAB drivers may be damaged.

Do not fasten screws while putting cables like those for interface or FL between LCD module and the enclosure.

Make sure to insert the module FL connector to the inverter connector in correct position.

If incorrect, this may cause smoke or burn of electrical parts by high voltage of FL circuit.

6) FL CABLES

Be careful not to pull the FL cables in order to avoid mechanical damage in FL lamp and soldering area.

While mounting, do not bind or twist the FL cables, or the Lamp current may not be applied as designed.

Be careful not to pull or not to hurt the FPC (Flexible Printed Circuit) cables.

3-6 OPERATION

Be sure that the following caution should be taken under assembly and inspection of the system.

1) POWER SUPPLY

Power supplies should always be turned off in connecting process.

Do not connect or disconnect the power cables and connectors with power applied to LCD module.

This may cause damage of module circuit.

2) INPUT SIGNAL

The signal should be applied after power supplies are turned on.

The signal should be removed before power supplies are turned off.

The detailed sequence of power supplies and signals are described in individual specifications.

3) LCD LONG PERIOD OPERATION

In case of LCD long period operation, discoloration of light guide or optical sheet will be happened due to ultra violet and heat from CCFL. As the result, there is possibility to have out of specification for the optical characteristic as "5.2".

But this is not irregular phenomena. Moreover, CCFL also has the characteristic of color shift by long period operation.

4) Longevity of FL

As the characteristic of FL, at the end of its life, the temperature at the edge of FL may rise higher and may give damages to the module. And/or breakage of FL tube may occur because of reduction of effective mercury that is contained in FL. So, when the FL reached the average longevity described on the specification or when FL tube lights pink, please replace the FL unit or LCD module immediately by above standards (reduction of luminance, changing color of discharge(white to pink), estimated longevity).

Be careful if the ambient temperature is below 25 degree Celsius, the longevity may be shorten from the average longevity (at 0 degree Celsius, its 1/10-1/20 approximately).

- b) To replace LCD modules, make sure that all power supplies, voltages, input signals and inverter for backlight should be completely turned off (not only to turn off at ON/OFF terminal, but ensure to turn off the power supply completely then replace LCD modules).

For Transportation and Storage

1) TEMPERATURE

Do not store LCD modules in high temperature, especially in high humidity for a long time (approximately more than one month).

It is strongly recommended to store LCD modules where the temperature is in the range of 0 to 35 degrees Celsius and the humidity is lower than 70%.

2) LOW TEMPERATURE

Liquid crystal material may be coagulated and LCD panel may be damaged at the lower temperature than storage temperature range described in individual specification.

3) ULTRA VIOLET RAY

Store LCD module without exposure to direct sunlight or fluorescent lamps in order to prevent the module from strong ultra violet ray.

4) CLEANLINESS

Keep the module in clean place, because any dust, hard particle may damage the polarizer, or dust invades the inside of the module.

5) *CONDENSATION OF WATER

Avoid condensation of water on LCD module, otherwise it may cause mis-operation or defects. Keep away LCD module from such ambient.

6) Gas

Among some of cardboards and rubber parts etc. generates corrosive gas, so it is advisable to confirm its reliability on the whole set or its packed condition.

7) PACKAGING

In case of transportation or storage after opening the original packaging, LCD modules are recommended to be repacked into the original packaging with the same method, especially with same kind of desiccant.

- CONTENTS -

Revision History	Sheet	1
Caution and Handling Precaution		2
1. Scope		12
2. Product Specifications		12
2.1 General Specifications			
2.2 Absolute Maximum Ratings			
2.3 Mechanical Specifications			
2.3.1 Weight			
2.3.2 Dimensional Outline			
2.4 Electrical Specifications			
2.4.1 Circuit Diagram			
2.4.2 Sequence of Power Supplies and Signals			
2.4.3 Timing Chart			
2.4.4 Timing Specifications			
2.4.5 Interface Connector			
2.4.6 Colors Combination Table			
3. Recommended Operating Conditions		23
4. Electrical Characteristics		24
4.1 Test Conditions			
4.2 Specifications			
5. Optical Characteristics		25
5.1 Test Conditions			
5.2 Optical Specifications			
6. Quality		26
6.1 Inspection AQL			
6.2 Test Conditions			
6.3 Dimensional Outline			
6.4 Appearance Test			
6.4.1 Test Conditions			
6.4.2 Specifications			
6.5 Display Quality			
6.5.1 Test Conditions			
6.5.2 Specifications			
6.6 Reliability Test			
6.6.1 Test Conditions			
6.6.2 Specifications			
6.7 Labels			
7. Lifetime		31
7.1 Module			
7.2 Lamp			
7.2.1 Test Conditions			
7.2.2 Specifications			
8. Packaging		32
8.1 Carton			
9. Warranty		33
10. Regulation		33
11. Measuring Method		33
11.1 Measuring Systems			
11.2 Measuring Methods			
12. EDID			

1. Scope

This specification is applicable to Toshiba Matsushita Display Technology's 31cm diagonal size TFT-LCD module "LTD121EXVV" designed for Personal Computer.

2. Product Specifications

2.1 General Specifications

Item	Specifications
Display Mode	TN color(64 gray scales, 262,144 colors) Transmissive type, Normally white
Viewing Direction	6 o'clock (in direction of maximum contrast)
Driving Method	TFT active matrix
Input Signals	LVDS interface CLK+,CLK- IN0+,IN0- IN1+,IN1- IN2+,IN2-
Active Area	261.12 (W) × 163.2 (H) (mm)
Bezel Opening	264.6 (W) × 166.6 (H) (mm)
Number of Pixels	1280 (W) × 800 (H) ¹⁾
Pixel Pitch	0.204 (W) × 0.204 (H) (mm) ¹⁾
Pixel Arrangement	RGB vertical stripes ¹⁾
Surface Treatment	Glare and hard coat 3H on LCD surface
Backlight	Single cold-cathode fluorescent lamp for sidelighting
Dimensional Outline	275.8 (W) × 178.0 (H) × 5.5max. (D) (mm)

Note 1)

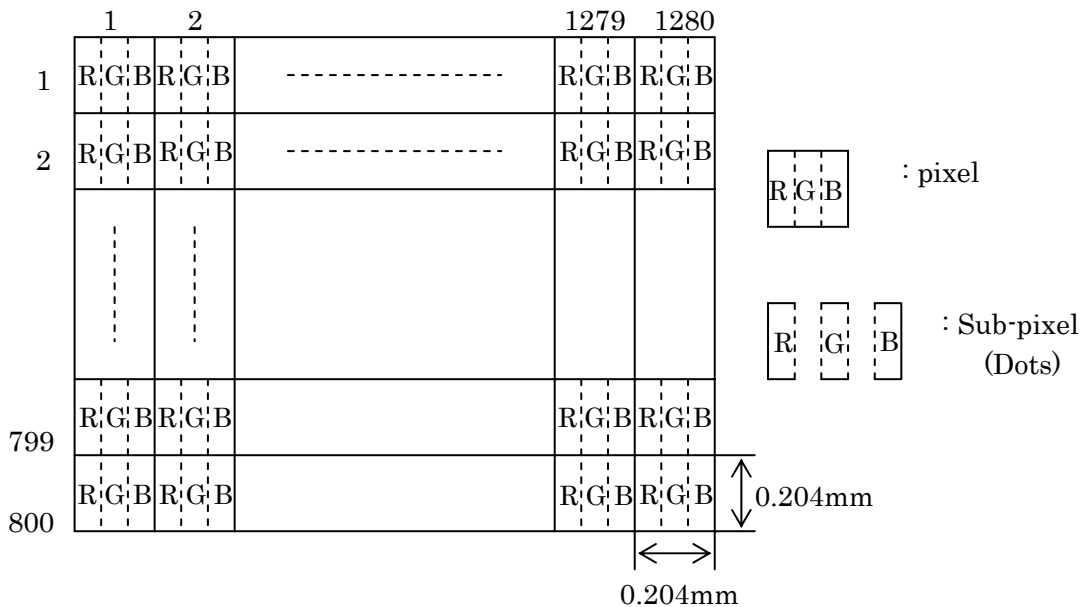

2.2 Absolute Maximum Ratings ¹⁾

Item	Symbol	Min.	Max.	Unit	Checked Terminal ⁴⁾
Supply Voltage	V_{DD}	-0.3	+4.0	V	$V_{DD} - GND$
Input Voltage of Signals	V_{IN}	-0.3	$V_{DD}+0.3$	V	LVDS interface
FL Driving Voltage	V_{FL}	-	2.0	kV(rms)	
FL Driving Frequency	f_{FL}	0	100	kHz	
Operating Ambient Temperature ²⁾	T_{OP}	0	+50	°C	
Operating Ambient Humidity ²⁾	H_{OP}	10	90	%(RH)	
Storage Temperature ²⁾	T_{STG}	-20	+60	°C	
Storage Humidity ²⁾	H_{STG}	10	90	%(RH)	
Operating Temperature for Panel ³⁾	-	0	+60	°C	

Note1) Do not exceed the maximum rating values under the worst probable conditions taking into account the supply voltage variation, input voltage variation, variation in part constants, and ambient temperature and so on. Otherwise the module may be damaged.

2) Wet bulb temperature should be 39°C Max, and no condensation of water. See figure below.

3) The surface temperature caused by self heat radiation of cell itself is specified on this item.

4) Refer to 2.4.5

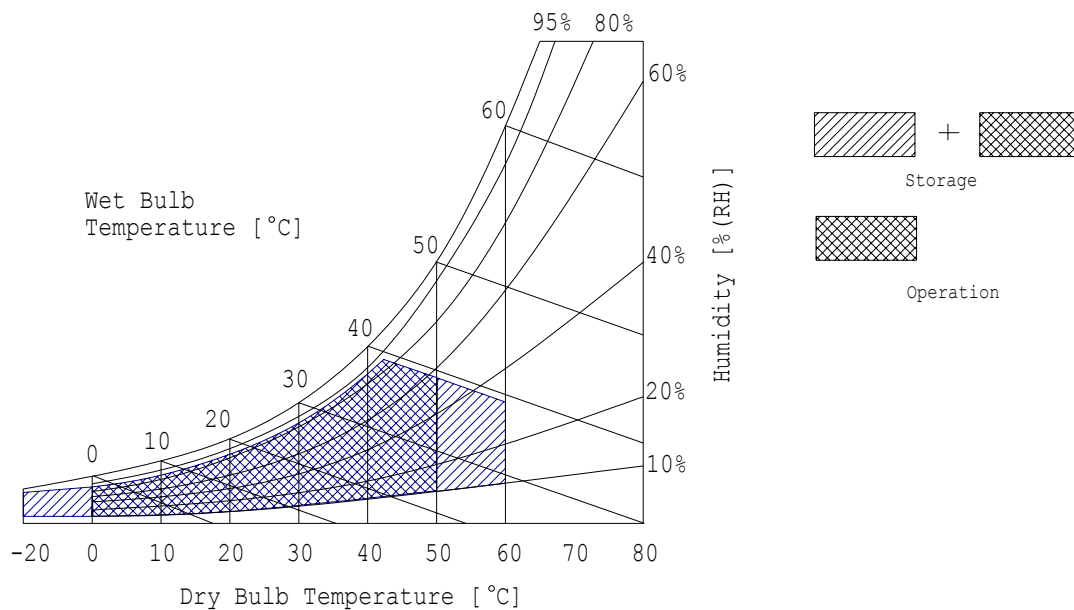

2.3 Mechanical Specifications

2.3.1 Weight

310 g(Typ.) +/- 20g

2.3.2 Dimensional Outline
(front figure)

Unit : mm
Standard Tolerance: ± 0.5

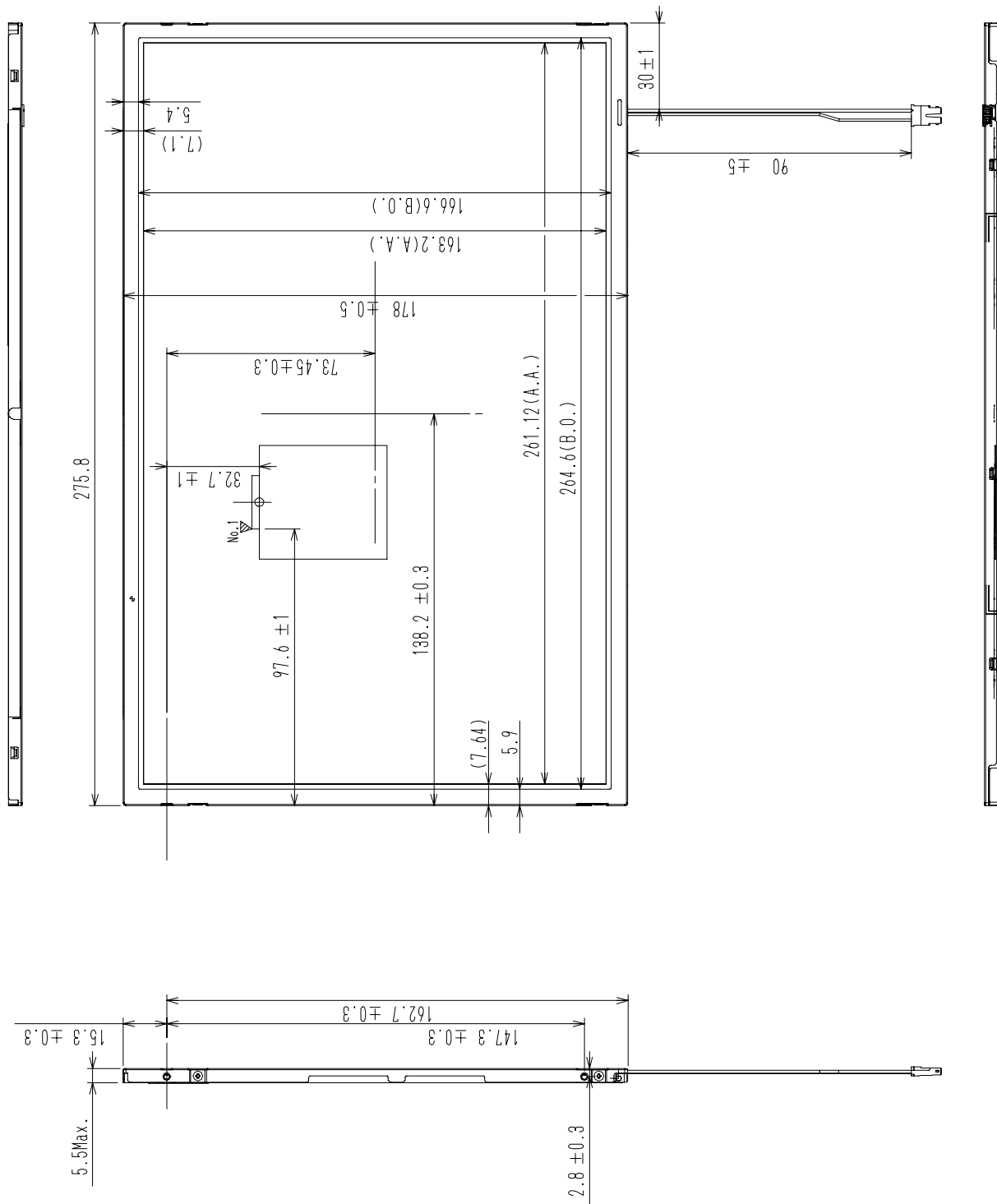

Note) If customer remove tape for fixing FL cable, Toshiba Matsushita Display Technology can not guarantee.

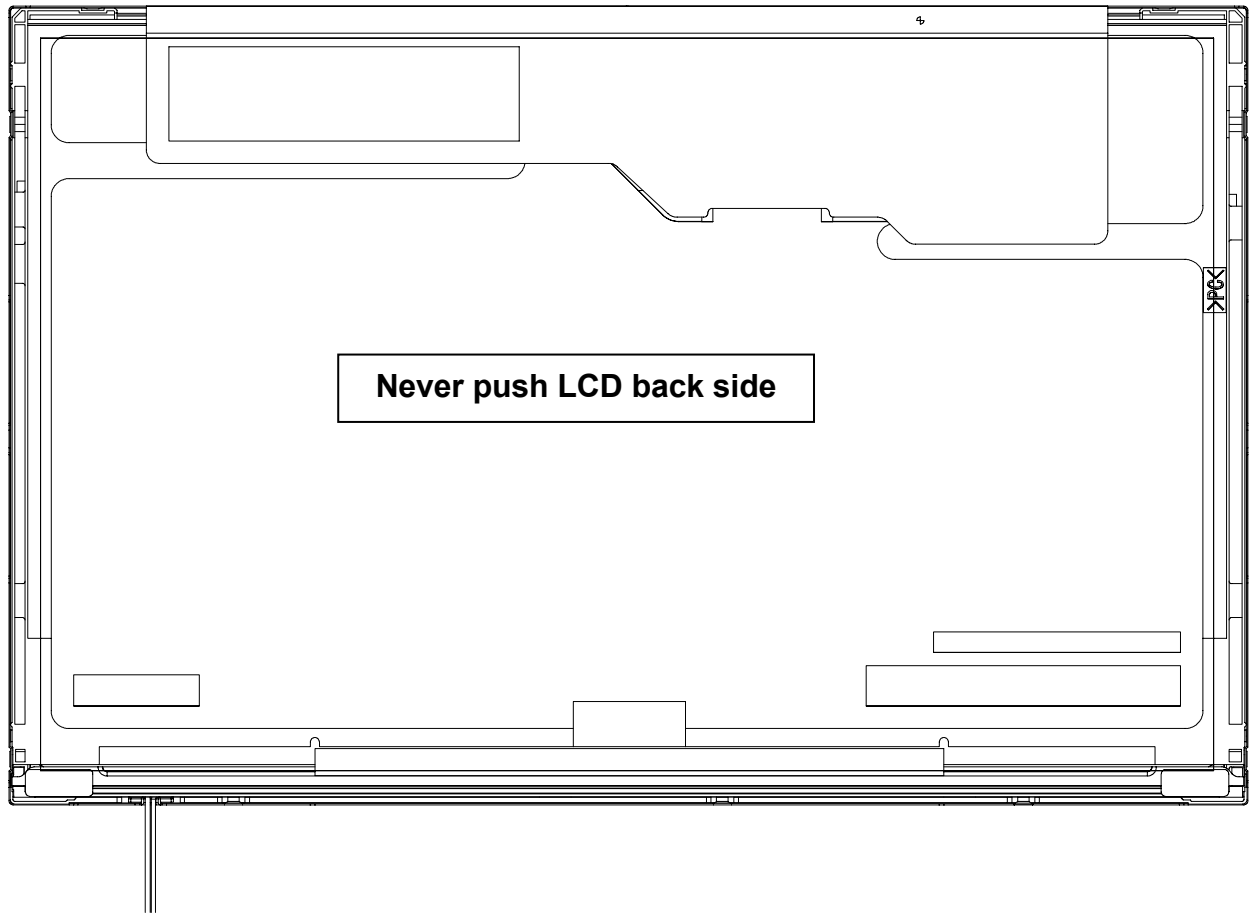
 **Warning**

Note) Never push LCD back side. If LCD back side was pressed, It may cause damage of the back light system.

2.4 Electrical Specifications

2.4.1 Circuit Diagram

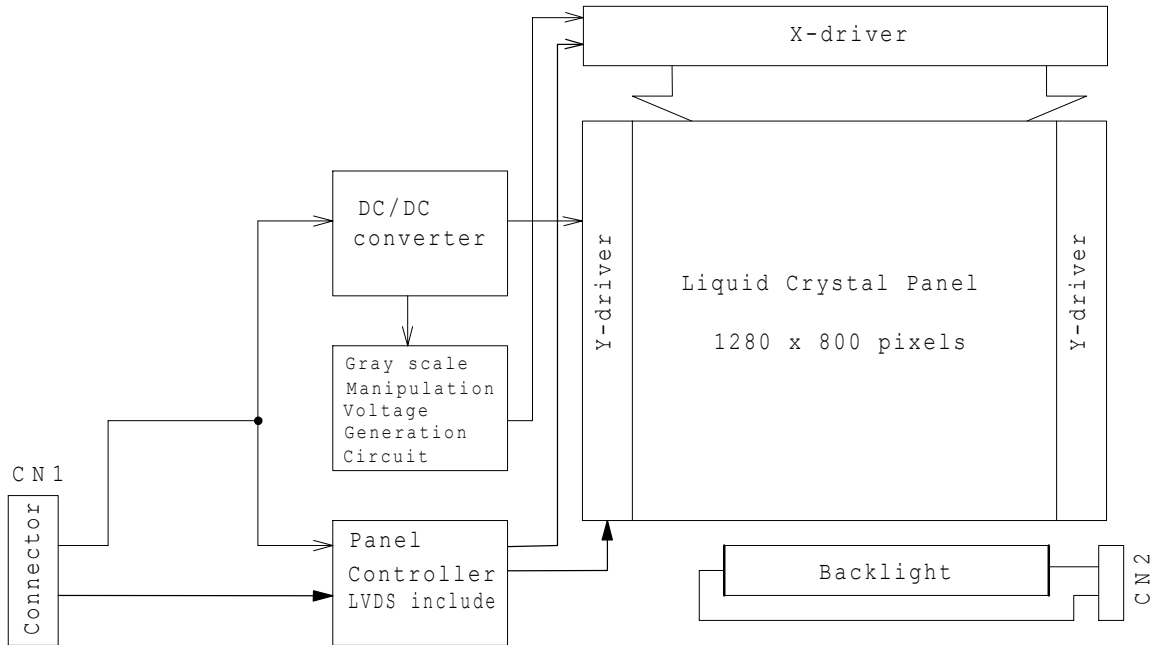

2.4.2 Sequence of Power Supplies and Signals

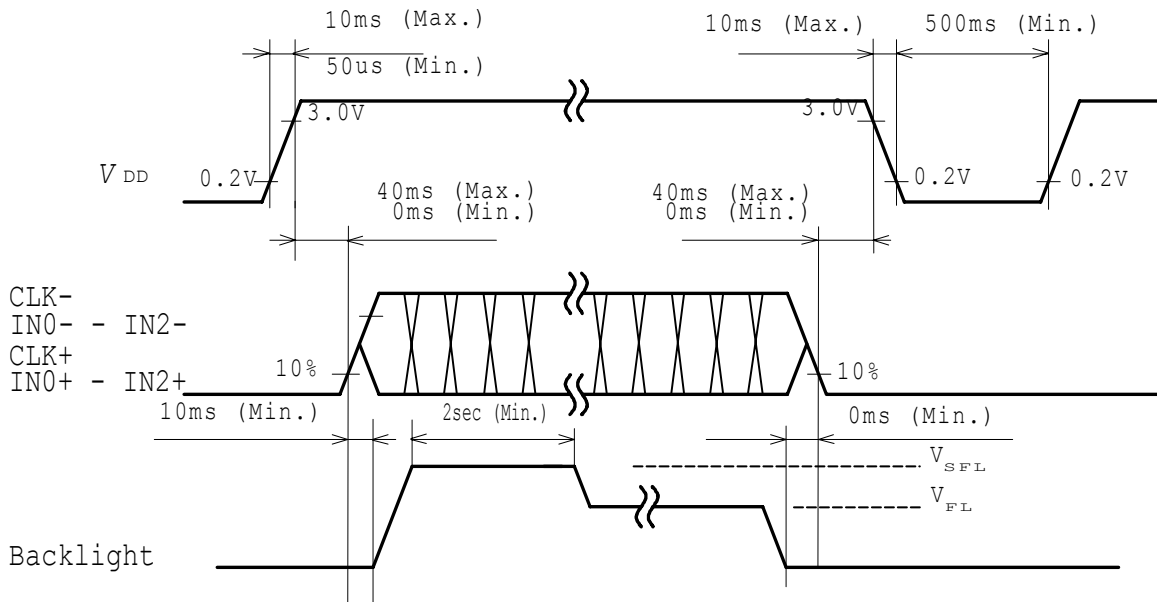

2.4.3 Timing Chart

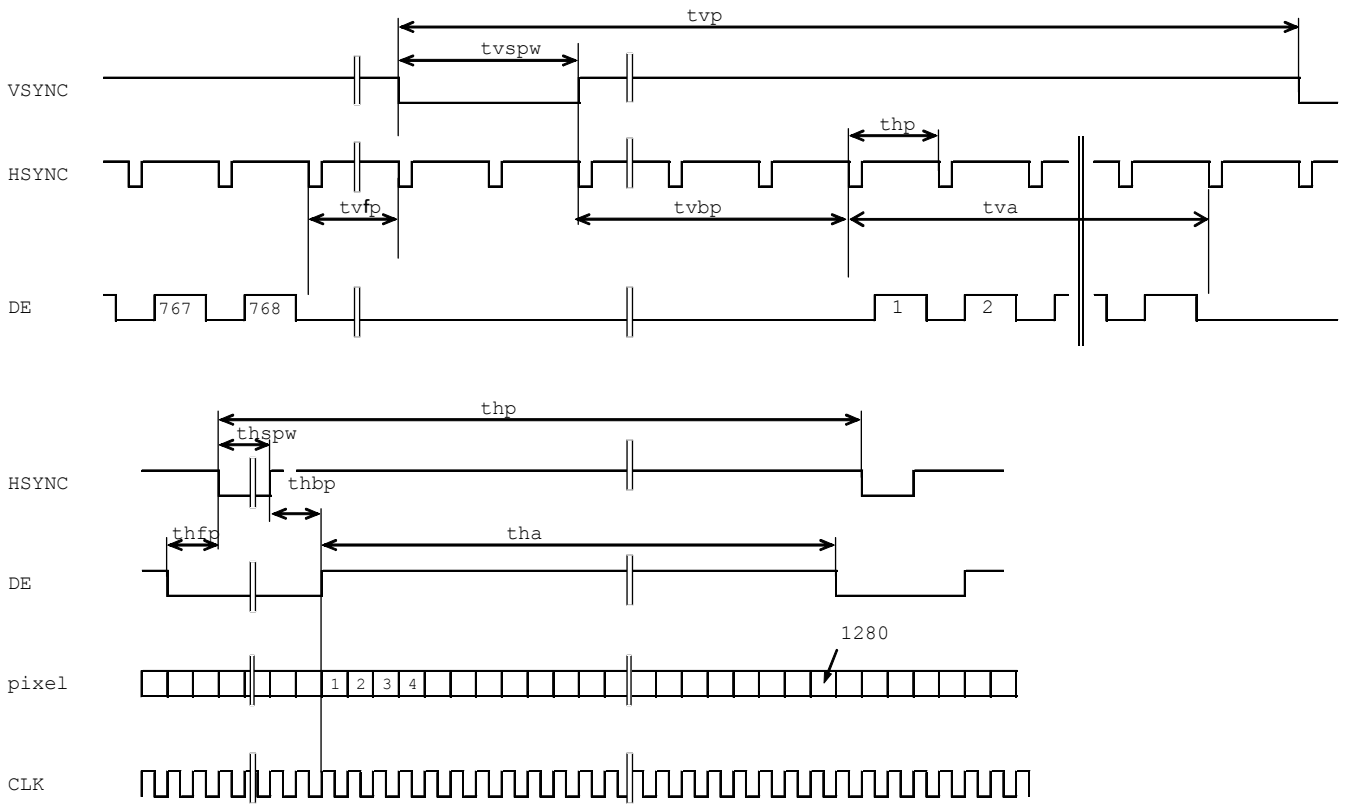

2.4.4 Timing Specifications ^{1) 2) 3) 4) 5) 6) 7)}

Item	Symbol	min.	typ.	max.	unit
Horizontal Scanning Term	<i>thp</i>	1660 x <i>tc</i>	1680 x <i>tc</i>	1710	clock
H-sync Pulse Width	<i>thspw</i>	4 x <i>tc</i>	128 x <i>tc</i>	-	clock
Horizontal Front Porch	<i>thfp</i>	4 x <i>tc</i>	72 x <i>tc</i>	-	clock
Horizontal Back Porch	<i>thbp</i>	4 x <i>tc</i>	200 x <i>tc</i>	-	clock
Horizontal Display Term	<i>tha</i>	1280 x <i>tc</i>	1280 x <i>tc</i>	1280 x <i>tc</i>	clock
Frame Period	<i>tv</i>	808 x <i>th</i>	831 x <i>th</i>	850 x <i>th</i>	line
V-sync Pulse Width	<i>tvspw</i>	1 x <i>th</i>	6 x <i>th</i>	-	line
Vertical Front Porch	<i>tvfp</i>	1 x <i>th</i>	3 x <i>th</i>	-	line
Vertical Back Porch	<i>tvbp</i>	2 x <i>th</i>	22 x <i>th</i>	-	line
Vertical Display Term	<i>tvd</i>	800 x <i>th</i>	800 x <i>th</i>	800 x <i>th</i>	line
Clock Period	<i>tc</i>	11.76	11.98	12.35	ns

Note 1) Refer to "Timing Chart" and LVDS (THC63LVDF84A-85) specifications by THine Electronics, Inc.

Note 2) If CLK is fixed to "H" or "L" level for certain period while DE is supplied, the panel may be damaged.

Note 3) Please adjust LCD operating signal timing and FL driving frequency, to optimize the display quality.

There is a possibility that flicker is observed by the interference of LCD operating signal timing and FL driving condition (especially driving frequency), even if the condition satisfies above timing specifications and recommended operating conditions shown in 3.

Note 4) Do not make *tv*, *th*, *thbp* and *tvds* fluctuate.

If *tv*, *th*, *thbp* and *tvds* are fluctuate, the panel displays black.

Note 5) In case of using the long frame period, the deterioration of display quality, noise etc. may be occurred.

Note 6) NCLK count of each Horizontal Scanning Time should be always the same.

V-Blanking period should be "*n*" X "Horizontal Scanning Time". (*n*: integer)

Frame period should be always the same.

2.4.5 Interface Connector

CN1 INPUT SIGNAL (DF19KR-20P-1H / HIROSE) : TENTATIVE

[Mating Connector : DF19G-20S-1C (Cable),

DF19G-20S-1F (FRC Type) / HIROSE]

Terminal No.	Symbol	Function
1	V _{SS}	GND
2	V _{DD}	Power Supply : +3.3V
3	V _{DD}	Power Supply : +3.3V
4	V _{EDID}	DDC 3.3V POWER SUPPLY : +3.3V
5	NC	Non-Connection
6	CLK _{EDID}	DDC Clock
7	DATA _{EDID}	DDC Data
8	RxIN0-	Negative LVDS differential data input (R0-R5,G0)
9	RxIN0+	Positive LVDS differential data input (R0-R5,G0)
10	V _{SS}	GND
11	RxIN1-	Negative LVDS differential data input (G1-G5, B0-B1)
12	RxIN1+	Positive LVDS differential data input (G1-G5, B0-B1)
13	V _{SS}	GND
14	RxIN2-	Negative LVDS differential data input (B2-B5, HS, VS, DE)
15	RxIN2+	Positive LVDS differential data input (B2-B5, HS, VS, DE)
16	V _{SS}	GND
17	CLK-	Clock Signal(-)
18	CLK+	Clock Signal(+)
19	V _{SS}	GND
20	V _{SS}	GND

Note 1) Please connect GND pin to ground. Don't use it as no-connect nor connection with high impedance.

Note 2) Please connect NC to nothing. Don't connect it to ground nor to other signal input.

CN2 CCFL POWER SOURCE (BHSR-02VS-1/JAPAN SOLDERLESS TERMINAL MFG CO., LTD.)

[Mating Connector : SM02B-BHS-1/JAPAN SOLDERLESS TERMINAL MFG CO., LTD.]

Terminal No.	Symbol	Function
1	V _{FLH}	CCFL POWER SUPPLY (HIGH VOLTAGE)
2	V _{FLL}	CCFL POWER SUPPLY (LOW VOLTAGE)

Note 1) 262,144 colors are displayed by the combinations of 18 bits data. (See next page)

**RECOMMENDED TRANSMITTER TRANSMITTER (THC63LVDF83A,THC63LVDM83A,THC63LVDM83A-85)
TO LTD121EXVV INTERFACE ASSIGNMENT**

Case1: 6Bit TRANSMITTER

Input Terminal No.		Input Signal (Graphics controller output signal)		Output Signal Symbol	To LTD121EXVV Interface(CN1)	
Symbol	Terminal	Symbol	Function		Terminal	Symbol
TIN0	44	R0	Red Pixels Display Data (LSB)	TOUT0- TOUT0+	No.8 No.9	RxIN0- RxIN0+
TIN1	45	R1	Red Pixels Display Data			
TIN2	47	R2	Red Pixels Display Data			
TIN3	48	R3	Red Pixels Display Data			
TIN4	1	R4	Red Pixels Display Data			
TIN5	3	R5	Red Pixels Display Data (MSB)			
TIN6	4	G0	Green Pixels Display Data (LSB)	TOUT1- TOUT1+	No.11 No.12	RxIN1- RxIN1+
TIN7	6	G1	Green Pixels Display Data			
TIN8	7	G2	Green Pixels Display Data			
TIN9	9	G3	Green Pixels Display Data			
TIN10	10	G4	Green Pixels Display Data			
TIN11	12	G5	Green Pixels Display Data (MSB)			
TIN12	13	B0	Blue Pixels Display Data (LSB)	TOUT2- TOUT2+	No.14 No.15	RxIN2- RxIN2+
TIN13	15	B1	Blue Pixels Display Data			
TIN14	16	B2	Blue Pixels Display Data			
TIN15	18	B3	Blue Pixels Display Data			
TIN16	19	B4	Blue Pixels Display Data			
TIN17	20	B5	Blue Pixels Display Data (MSB)			
TIN18	22	HSYNC	H-Sync	TCLK OUT- TCLK OUT+	No.17 No.18	CLK IN- CLK IN+
TIN19	23	VSYNC	V-Sync			
TIN20	25	DE	Compound Synchronization Signal			
CLK IN	26	NCLK	Data Sampling Clock			

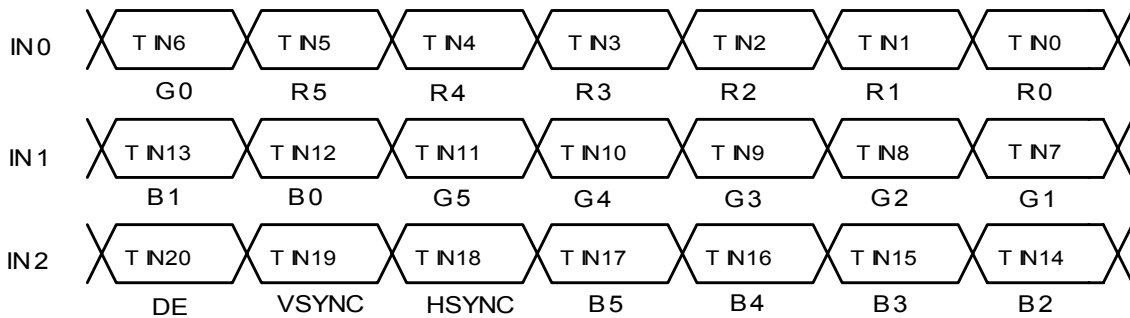

**RECOMMENDED TRANSMITTER (THC63LVDF83A,THC63LVDM83A,THC63LVDM83A-85)
TO LTD121EXVV INTERFACE ASSIGNMENT**

Case2: 8Bit TRANSMITTER

Input Terminal No.		Input Signal (Graphics controller output signal)		Output Signal Symbol	To LTD121EXVV Interface(CN1)	
Symbol	Terminal	Symbol	Function		Terminal	Symbol
TIN0	51	R0	Red Pixels Display Data (LSB)	TOUT0- TOUT0+	No.8 No.9	RxIN0- RxIN0+
TIN1	52	R1	Red Pixels Display Data			
TIN2	54	R2	Red Pixels Display Data			
TIN3	55	R3	Red Pixels Display Data			
TIN4	56	R4	Red Pixels Display Data			
TIN5	3	R5	Red Pixels Display Data (MSB)			
TIN6	4	G0	Green Pixels Display Data(LSB)	TOUT1- TOUT1+	No.11 No.12	RxIN1- RxIN1+
TIN7	6	G1	Green Pixels Display Data			
TIN8	7	G2	Green Pixels Display Data			
TIN9	11	G3	Green Pixels Display Data			
TIN10	12	G4	Green Pixels Display Data			
TIN11	14	G5	Green Pixels Display Data(MSB)			
TIN12	15	B0	Blue Pixels Display Data (LSB)	TOUT2- TOUT2+	No.14 No.15	RxIN2- RxIN2+
TIN13	19	B1	Blue Pixels Display Data			
TIN14	20	B2	Blue Pixels Display Data			
TIN15	22	B3	Blue Pixels Display Data			
TIN16	23	B4	Blue Pixels Display Data			
TIN17	24	B5	Blue Pixels Display Data (MSB)			
TIN18	27	HSYNC	H-Sync	TOUT3- TOUT3+	-	-
TIN19	28	VSYNC	V-Sync			
TIN20	30	DE	Compound Synchronization Signal			
TIN21	50	NC	Non Connection (open)			
TIN22	2	NC	Non Connection (open)			
TIN23	8	NC	Non Connection (open)			
TIN24	10	NC	Non Connection (open)	TCLK OUT- TCLK OUT+	No.17 No.18	CLK IN- CLK IN+
TIN25	16	NC	Non Connection (open)			
TIN26	18	NC	Non Connection (open)			
TIN27	25	NC	Non Connection (open)			
CLK IN	31	NCLK	Data Sampling Clock			

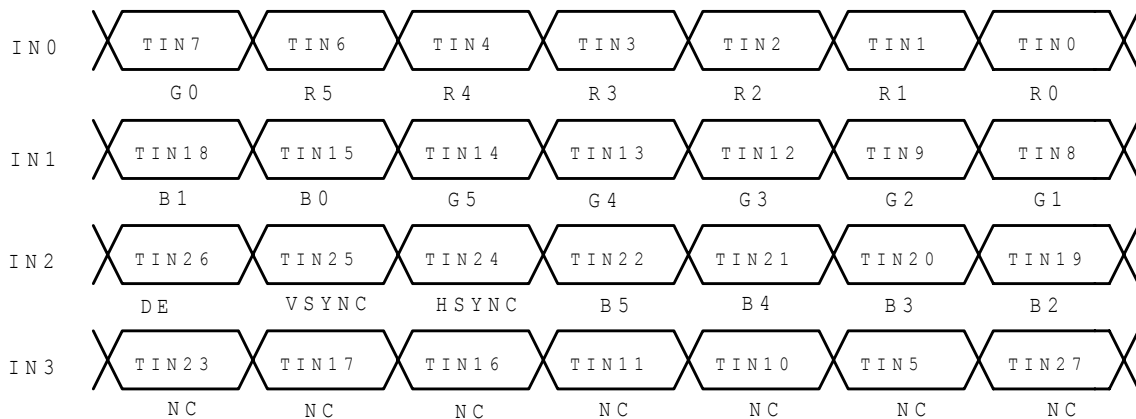

2.4.6 Colors Combination Table

	Display	R5 R4 R3 R2 R1 R0	G5 G4 G3 G2 G1 G0	B5 B4 B3 B2 B1 B0	Gray ScaleLevel
Basic Color	Black	L L L L L L	L L L L L L	L L L L L L	-
	Blue	L L L L L L	L L L L L L	H H H H H H	-
	Green	L L L L L L	H H H H H H	L L L L L L	-
	Light Blue	L L L L L L	H H H H H H	H H H H H H	-
	Red	H H H H H H	L L L L L L	L L L L L L	-
	Purple	H H H H H H	L L L L L L	H H H H H H	-
	Yellow	H H H H H H	H H H H H H	L L L L L L	-
	White	H H H H H H	H H H H H H	H H H H H H	-
Gray Scale of Red	Black	L L L L L L	L L L L L L	L L L L L L	L 0
	Dark ↑ ↓ Light	L L L L L H	L L L L L L	L L L L L L	L 1
		L L L L H L	L L L L L L	L L L L L L	L 2
		∴	∴	∴	L3... L60
	Light	H H H H L H	L L L L L L	L L L L L L	L61
		H H H H H L	L L L L L L	L L L L L L	L62
Red	H H H H H H	L L L L L L	L L L L L L	Red L63	
Gray Scale of Green	Black	L L L L L L	L L L L L L	L L L L L L	L 0
	Dark ↑ ↓ Light	L L L L L H	L L L L L L	L L L L L L	L 1
		L L L L L L	L L L L H L	L L L L L L	L 2
		∴	∴	∴	L3... L60
	Light	L L L L L L	H H H H L H	L L L L L L	L61
		L L L L L L	H H H H H L	L L L L L L	L62
Green	L L L L L L	H H H H H H	L L L L L L	Green L63	
Gray Scale of Blue	Black	L L L L L L	L L L L L L	L L L L L L	L 0
	Dark ↑ ↓ Light	L L L L L H	L L L L L L	L L L L L H	L 1
		L L L L L L	L L L L L L	L L L L H L	L 2
		∴	∴	∴	L3... L60
	Light	L L L L L L	L L L L L L	H H H H L H	L61
		L L L L L L	L L L L L L	H H H H H L	L62
Blue	L L L L L L	L L L L L L	H H H H H H	Blue L63	
Gray Scale of White & Black	Black	L L L L L L	L L L L L L	L L L L L L	L 0
	Dark ↑ ↓ Light	L L L L L H	L L L L L H	L L L L L H	L 1
		L L L L H L	L L L L H L	L L L L H L	L 2
		∴	∴	∴	L3... L60
	Light	H H H H L H	H H H H L H	H H H H L H	L61
		H H H H H L	H H H H H L	H H H H H L	L62
White	H H H H H H	H H H H H H	H H H H H H	white L63	

Note1 L: Low level voltage, H: High level voltage

3. Recommended Operating Conditions ^{1) 2) 3) 10)}

Item	Symbol	Min.	Typ.	Max.	Unit	Remarks
Supply Voltage ⁴⁾	V_{DD}	3.0	3.3	3.6	V	
Comon Mode Input Voltage	V_{CM}	0.8	-	1.75	V	
Differential Input amplitude	V_{ID}	100	-	600	mV	
Differential Input Voltage		$V_{CM}-(V_{ID})/2$		$V_{CM}+(V_{ID})/2$	V	
FL Input Current ^{6) 7) 8)}	I_{FL}	2.0	-	6.0	mA(rms)	
FL Driving Voltage ⁶⁾	V_{FL}	580	630	680	V(rms)	$I_{FL}=6.0\text{mA(rms)}$ (Reference)
FL Driving Frequency ⁶⁾	f_{FL}	40	50	80	kHz	
FL Starting Voltage ^{6) 9)}	V_{SFL}	1500	-	1800	V(rms)	0°C

Note 1) The module should be always operated within these ranges. The "Typ." shows the recommendable value.

2) Recommended LVDS transmitter: THC63LVDF63A, THC63LVDM63A, THC63LVDM63A-85, THC63LVDF83A, THC63LVDM83A, THC63LVDM83A-85 (made by Thine Electronics, Inc.)

Panel Controller contains LVDS, which is based on THC63LVDF84A-85 (made by Thine Electronics, Inc.) specification.

3) LVDS is based on TIA/EIA 644

However, Common mode input voltage should be 0.8-1.75V.

3) Checked Pin Terminal: V_{DD} , GND (0V)

4) Checked Pin Terminal: IN0~CLK+, GND (0V)

Measure: $|V_{IN0+}-V_{IN0-}|$, $|V_{IN1+}-V_{IN1-}|$, $|V_{IN2+}-V_{IN2-}|$
 $|V_{CLKN+}-V_{CLK-}|$

Measure: $(V_{IN0+}-V_{IN0-})/2$, $(V_{IN1+}-V_{IN1-})/2$,
 $(V_{IN2+}-V_{IN2-})/2$, $(V_{CLK+}-V_{CLK-})/2$,

5) Checked Pin Terminal: V_{FLH} - F_{FLL}

6) If FL input current (I_{FL}) is higher than typical

value(6.0mA(rms)), then FL lifetime becomes shorter.

7) Measuring Method of I_{FL} .

8) Input FL starting voltage (V_{SFL}) should not be less than two second.

If it were less than two second, it may cause unstable operation of FL.

9) Please adjust LCD operating signal timing and FL driving frequency, to optimize the display quality.

There is a possibility that flicker is observed by the interference of LCD operating signal timing and FL driving condition (especially driving frequency), even if the condition satisfies above recommended operating conditions and timing specifications shown in 2.4.4.

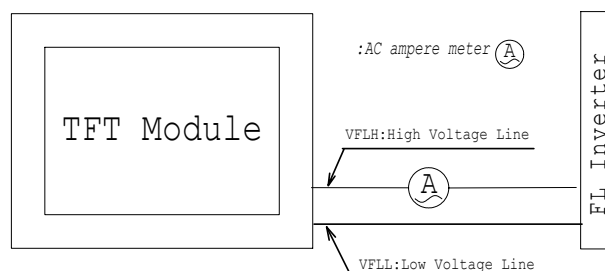

4. Electrical Characteristics

4.1 Test Conditions

Ambient Temperature	: T_a	25±5°C
Ambient Humidity	: H_a	65±20%(RH)
Supply Voltage	: V_{DD}	3.3V
Input Signal	: Refer typical value in "2.4.4 Timing Specifications".	
FL Input Current	: I_{FL}	6.0mA(rms)
FL Driving Frequency	: f_{FL}	50kHz

4.2 Specifications

Item	Symbol	Min.	Typ. ¹⁾	Max.	Unit	Remark
Current Consumption	I_{DD}	-	240	400	mA	V_{DD} Terminal Current

Note 1) The Typical value of I_{DD} is measured in the following pattern.

1. White
2. Yellow
3. Purple
4. Red
5. Light Blue
6. Green
7. Blue
6. Black

1	2	3	4	5	6	7	8
---	---	---	---	---	---	---	---

5. Optical Characteristics

5.1 Test Conditions

It is same as 4.1

The measuring method is shown in 11.

5.2 Optical Specifications ¹⁾

Item	Symbol	Conditions	Specifications			Unit	Remark	
			Min.	Typ	Max.			
Viewing Angle	θ	$CR \geq 10$	$\phi = 180^\circ$	10	-	-	°	
			$\phi = 0^\circ$	20	-	-	°	
			$\phi = 90^\circ$	30	-	-	°	
			$\phi = -90^\circ$	30	-	-	°	
Contrast Ratio	CR	$\theta = 0^\circ, \phi = 0^\circ$	300	600	-	-		
Response Time	$t_{ON} + t_{OFF}$	$\theta = 0^\circ, \phi = 0^\circ$	-	-	50	ms		
Luminance	L	$\theta = 0^\circ, \phi = 0^\circ$ Gray Scale Level=L63 (White)	160	200	-	cd/m ²	$I_{FL} = 6.0\text{mA(rms)}$ 5point	
Luminance Uniformity ²⁾	LUNF	$\theta = 0^\circ, \phi = 0^\circ$ Gray Scale Level=L63 (White)	-	-	1.6		L_{max} / L_{min}	
Chromaticity	Red	x_R	Gray Scale Level:L63 $\theta = 0^\circ, \phi = 0^\circ$	0.550	0.600	0.650	-	
		y_R		0.290	0.340	0.390	-	
	Green	x_G	Ditto	0.260	0.310	0.360	-	
		y_G		0.500	0.550	0.600	-	
	Blue	x_B	Ditto	0.100	0.150	0.200	-	
		y_B		0.085	0.135	0.185	-	
	White	x_W	Ditto	0.275	0.315	0.355	-	
		y_W		0.290	0.330	0.370	-	

Note 1): Refer to "11. Measuring Method".

Note 2): The above test limit must be applied for initial use. Characteristics will be shifted by long period operation, but it is not irregular phenomena. Theoretically brightness characteristics will be decreased due to CCFL degradation and color shift due to optical components change.

6. Quality

6.1 Inspection AQL

Total of Major Defects	: AQL 0.65 %
Total of Minor Defects	: AQL 1.5 %
Sampling Method	: ISO 2859-1 : 1999

6.2 Test Conditions

1) Ambient Temperature	: 25±5°C
2) Ambient Humidity	: 65±20%(RH)
3) Illumination	: Approximately 500 lx under the fluorescent lamp
4) Viewing Distance	: Approximately 30cm by the eyes of the inspector from the module
5) Inspection Angle	: $\theta=0^\circ$, $\phi=0^\circ$

6.3 Dimensional Outline

The products shall conform to the dimensions specified in 2.3.2.

Definition of Major and Minor defects are as follows.

Item	Description	Class
Important Dimensions	Dimensional outline, Dimensional between the mounting holes(hinge)	Major
Others	Dimensions specified in this specifications	Minor

6.4 Appearance Test

6.4.1 Test Conditions

- 1) Condition : Non-operating, operating (Pattern : L63 white raster)
Same as 6.2

6.4.2 Specifications

Item	Description	Class												
PCB Appearance	Pattern peeling snapping, electrically short	Major												
	Repair portion on PCB is not covered by epoxy resin													
Soldering	Cold solder joint, lead move when pulled	Minor												
Bezel, Frame, Connectors	Distinct stain, rust or scratch	Major												
Black and White Spots/Lines ¹⁾²⁾	<table border="1" style="width: 100%; border-collapse: collapse;"> <thead> <tr> <th>Line width</th> <th>Length(mm)</th> <th>Acceptable count</th> </tr> </thead> <tbody> <tr> <td>$W \leq 0.05$</td> <td rowspan="4" style="text-align: center;">$L \leq 3$</td> <td>neglect</td> </tr> <tr> <td>$0.05 < W \leq 0.07$</td> <td>$n \leq 8$</td> </tr> <tr> <td>$0.07 < W \leq 0.10$</td> <td>$n \leq 2$</td> </tr> <tr> <td>$0.10 < W$</td> <td>²⁾</td> </tr> </tbody> </table>	Line width	Length(mm)	Acceptable count	$W \leq 0.05$	$L \leq 3$	neglect	$0.05 < W \leq 0.07$	$n \leq 8$	$0.07 < W \leq 0.10$	$n \leq 2$	$0.10 < W$	²⁾	Minor
	Line width	Length(mm)	Acceptable count											
	$W \leq 0.05$	$L \leq 3$	neglect											
	$0.05 < W \leq 0.07$		$n \leq 8$											
	$0.07 < W \leq 0.10$		$n \leq 2$											
	$0.10 < W$		²⁾											
	<table border="1" style="width: 100%; border-collapse: collapse;"> <thead> <tr> <th>Average diameter(mm)</th> <th>Acceptable count/side</th> </tr> </thead> <tbody> <tr> <td>$D \leq 0.2$</td> <td>neglect</td> </tr> <tr> <td>$0.2 < D \leq 0.3$</td> <td>$n \leq 5$</td> </tr> <tr> <td>$0.3 < D \leq 0.5$</td> <td>$n \leq 2$</td> </tr> <tr> <td>$0.5 < D$</td> <td>0</td> </tr> </tbody> </table>	Average diameter(mm)	Acceptable count/side	$D \leq 0.2$	neglect	$0.2 < D \leq 0.3$	$n \leq 5$	$0.3 < D \leq 0.5$	$n \leq 2$	$0.5 < D$	0			
	Average diameter(mm)	Acceptable count/side												
	$D \leq 0.2$	neglect												
	$0.2 < D \leq 0.3$	$n \leq 5$												
$0.3 < D \leq 0.5$	$n \leq 2$													
$0.5 < D$	0													

Note 1) Inspection area should be within viewing area.

Note 2) Black/White Spot, Polarizer Dents and Polarizer Bubble shall be judged by "Average Diameter".

Average Diameter $D = (a+b) / 2$ (mm)

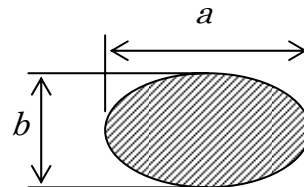

6.5 Display Quality

6.5.1 Test Conditions

- 1) Inspection Area : Within active area
 2) Driving Condition : Same as test conditions shown in 4.1 and 6.2
 3) Test Pattern : White display pattern (gray scale level L63) and black display pattern (gray scale level L0)

6.5.2 Specifications ⁴⁾

Item	Description / Specifications	Class																			
Function	No display, Malfunction	Major																			
Display Quality ¹⁾	Missing line	Major																			
	Missing Sub-Pixels <table border="1" data-bbox="533 741 1323 1059"> <tbody> <tr> <td>1) Bright defects²⁾³⁾</td> <td>2pcs. max.</td> </tr> <tr> <td>2) Dark defects ²⁾</td> <td>4pcs. max.</td> </tr> <tr> <td>3) Total sub-pixel defects</td> <td>5pcs. max.</td> </tr> <tr> <td>4) 2 Conjunction Bright defects</td> <td>1 set max.</td> </tr> <tr> <td>5) 3 Conjunction Bright defects</td> <td>0 set max.</td> </tr> <tr> <td>6) 2 Conjunction Dark defects</td> <td>1 set max.</td> </tr> <tr> <td>7) 3 Conjunction Dark defects</td> <td>0 set max.</td> </tr> <tr> <td>8) Bright defect to Bright defect distance</td> <td>15mm min</td> </tr> <tr> <td>9) Dark defect to dark defect distance</td> <td>5mm min.</td> </tr> <tr> <td>10) Other Item</td> <td>Neglect</td> </tr> </tbody> </table>	1) Bright defects ²⁾³⁾	2pcs. max.	2) Dark defects ²⁾	4pcs. max.	3) Total sub-pixel defects	5pcs. max.	4) 2 Conjunction Bright defects	1 set max.	5) 3 Conjunction Bright defects	0 set max.	6) 2 Conjunction Dark defects	1 set max.	7) 3 Conjunction Dark defects	0 set max.	8) Bright defect to Bright defect distance	15mm min	9) Dark defect to dark defect distance	5mm min.	10) Other Item	Neglect
1) Bright defects ²⁾³⁾	2pcs. max.																				
2) Dark defects ²⁾	4pcs. max.																				
3) Total sub-pixel defects	5pcs. max.																				
4) 2 Conjunction Bright defects	1 set max.																				
5) 3 Conjunction Bright defects	0 set max.																				
6) 2 Conjunction Dark defects	1 set max.																				
7) 3 Conjunction Dark defects	0 set max.																				
8) Bright defect to Bright defect distance	15mm min																				
9) Dark defect to dark defect distance	5mm min.																				
10) Other Item	Neglect																				
	Inconspicuous flicker, crosstalk, Newton's ring, Mottling Rubbing defect, Dim Lines, Horizontal Line and Vertical Line. : neglect	-																			
Black and White Spots/lines	Inconspicuous defects : neglect	-																			
Backlight	Missing (Non-operating)	Major																			

Note 1) Defects of both color filter and black matrix are counted as bright or dark defects.

Inspection area should be within the active area.

Note 2) Bright defect means a bright spot(sub-pixel) on the display pattern of gray scale L0.

Dark defect means a dark spot(sub-pixel) on the display pattern of gray scale L63.

Note 3) Bright spot which can not be found by using 5%ND-Filter shall not be counted as a defect.

Note 4) When display power turned off, the display image quality is not restricted to above specifications.

6.6 Reliability Test

6.6.1 Test Conditions

- 1) The module should be driven and inspected under normal test conditions.
- 2) The module should not have condensation of water (moisture) on the module.
- 3) The module should be inspected after two or more hours storage in normal conditions (15 - 35°C, 45 - 65%(RH)).
- 4) A module shall be used only for one test.

6.6.2 Specifications

The module shall have no failure in the following reliability test items.

Test Item	Test Conditions	Result
High Temperature Operation ¹⁾	50°C 192 h	3p/3p OK
High Temperature Storage ²⁾	60°C 192 h	3p/3p OK
High Temperature and High Humidity operation ¹⁾	50°C 80% 192 h	3p/3p OK
Low Temperature Operation ¹⁾	0°C 192 h	3p/3p OK
Low Temperature Storage ²⁾	-20°C 192 h	3p/3p OK
Temperature Shock ²⁾	-20°C ⇔ 60°C 0.5h 0.5h 50 cycles	3p/3p OK
Mechanical Vibration ²⁾	10 – 200 - 10Hz sweep/cycle, 1.5×9.8m/s ² constant, X.Y.Z each direction, 0.5h each	3p/3p OK
Mechanical Shock ²⁾	50×9.8m/s ² , 20ms, ±X, ±Y, ±Z each direction, one time each	3p/3p OK

Note 1) Operating

Note 2) Non-Operating

Definitions of failure for judgment shall be as follows:

- 1) Function of the module should be maintained.
- 2) Current consumption should be smaller than the specified value.
- 3) Appearance and display quality should not have distinguished degradation.
- 4) Luminance should be larger than 50% of the minimum value specified in 5.2.

6.7 Labels

(1) Product Label

Serial number : △△ ▲ 6A 000001

① ② ③ ④

- ① : Module type code
- ② : Manufacturing code
- ③ : Lot code 6 A
(1) (2)

(1):Year code-end of the A.D.
(2):Month code-alphabet → Jan. : A - Dec. : L

Bar code : CODE-39 High-density
(Example : 6A → 2006 JAN.)

- ④: Serial code
decimal, 6 figures

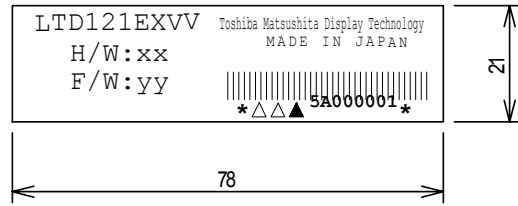

(2) Caution Labels

• High Voltage

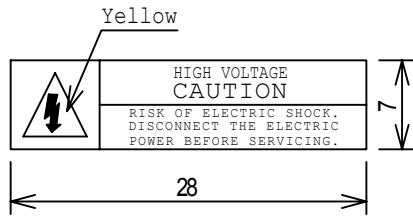

• Disposal of CCFL

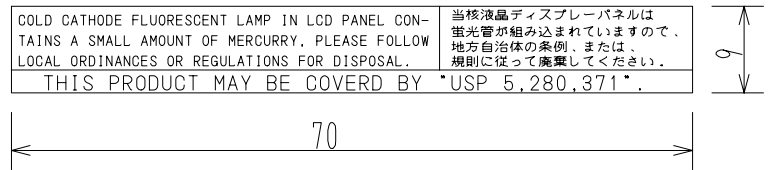

Unit: mm

3) Label Locations

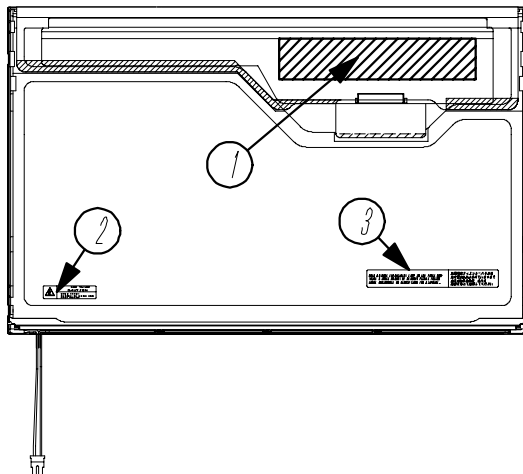

- ①:Product Label
- ②:Caution Label
- ③:Disposal of CCFL

7. Lifetime

7.1 Module (except lamp)

MTTF (Mean Time To Failure) : 50,000 h

(This value is not assurance time but inference value by following conditions.)

Conditions : Ambient temperature : 25±5°C (No wind)

Ambient humidity : 65%(RH)

7.2 Lamp

7.2.1 Test Conditions

Ambient temperature : 25±5°C (No wind)

Lamp current : 6.0mA(rms)

Lighting condition : continuous lighting

Driving frequency : 50kHz

7.2.2 Specifications

MTBF : 10,000 h

Definitions of failure for judgment shall be as follows.

- 1) LCD luminance becomes half of the minimum value specified in 5.2.
- 2) Lamp doesn't light normally.

(Note1) In case of LCD long period operation, discoloration of light guide or optical sheet will be happened due to ultra violet and heat from CCFL. As the result, there is possibility to have out of specification for the optical characteristics as "4.3.2". But this is not irregular phenomena. Moreover, CCFL also has the characteristic of color shift by long period operation.

8. Packaging

8.1 Carton (internal package)

(1) Packaging Form

Corrugated cardboard box and polyethylene foam as shock absorber

(2) Packaging Method ¹⁾²⁾

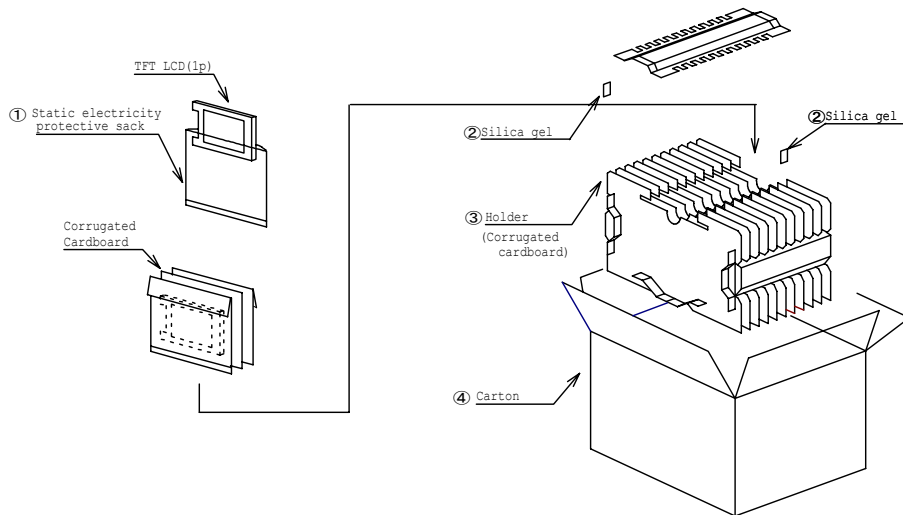

Note 1): Total weight : (Approx.) 9.5 kg

Note 2): Acceptable number of palette piling: 2 sets

(3) Packaging Material

Number	Quantity	Description
①	25p	Static electricity Protective sack
②	3p	Silicagel(100g×3p)
③	1set	Holder
④	1p	Corrugated card box
⑤	1p	Plastics adhesive tape

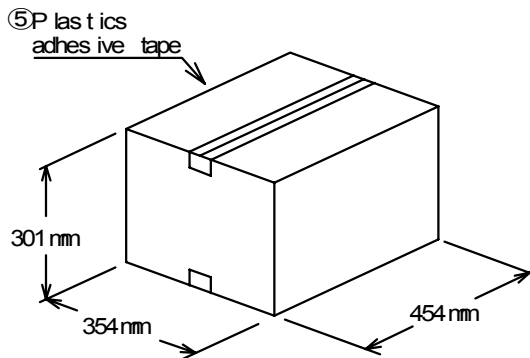

(4) Carton Marking

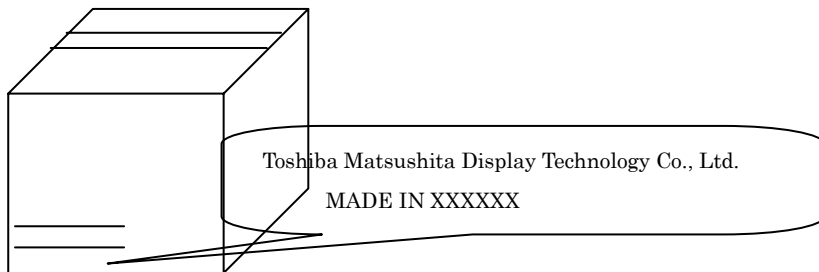

9. Warranty

Warranty clause will be decided separately.

10. Regulation

The set (which our LCD module is assembled into) to conform the regulations below, take measures in set side. Toshiba Matsushita Display Technology is not liable for the regulations to the complete set, nor can guarantee our LCD module conform the regulation by itself.

a) Examples of EMI Regulations

FCC : PART15 CLASS B

VCCI : CLASS B

CISPR : CLASS B

b) Examples of Safety Regulations

IEC 60950

UL 60950

11. Measuring Method

11.1 Measuring System

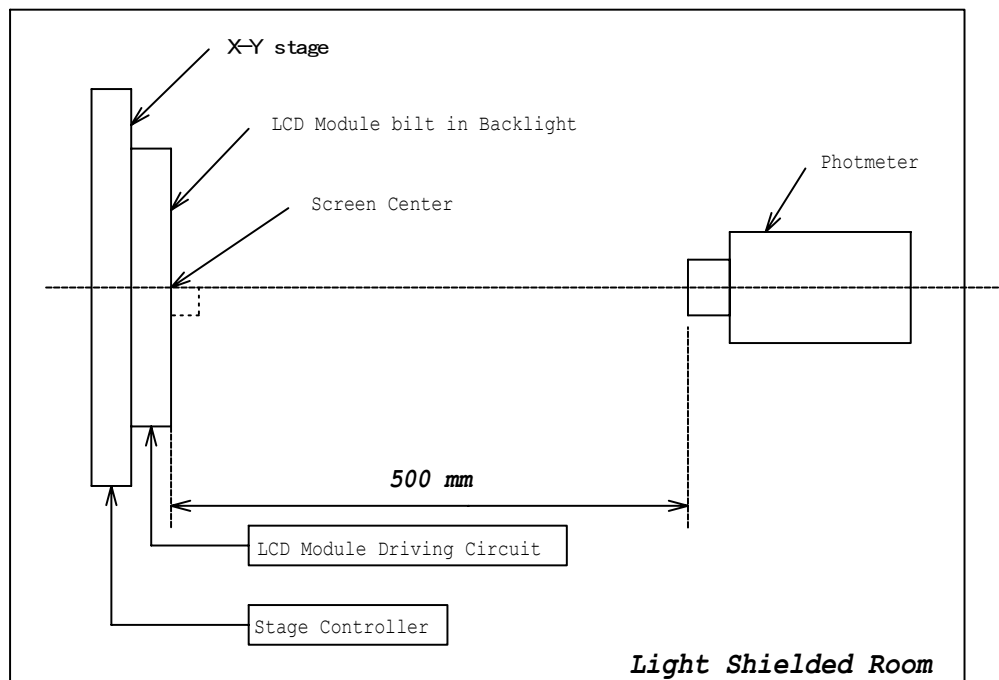

(1) The measurement point is the center of the active area except for the measurement of Luminance Uniformity.

(2) Photometer : BM-5A / BM-7 TOPCON (Aperture 2°)

(3) Definition of ϕ and θ :

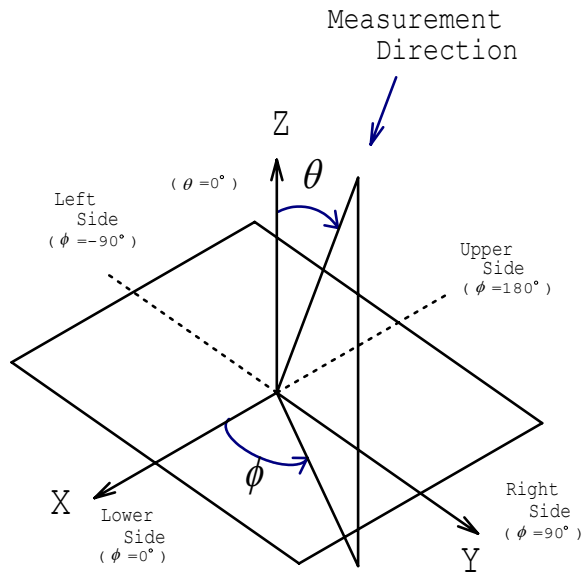

11.2 Measuring Methods

(1) Luminance:

The luminance of the center on a white raster (gray scale level L63) shall be measured.
Measurement shall be executed 30 minutes after the lamp is lit up.

(2) Contrast Ratio:

The contrast ratio can be calculated by the following expression.

$$\text{Contrast Ratio (CR)} = L63 / L0$$

L63 : Luminance on the white raster (gray scale level L63)

L 0 : Luminance on the black raster (gray scale level L0)

(3) Viewing Angle

Viewing angle is defined as the angles(θ , ϕ), in which specified contrast ratio can be obtained.
(Refer to 11.1(3) for the axes.)

(4) Luminance Uniformity:

The Luminance should be measured at 13 positions on white raster(gray scale level L63).
 Uniformity can be calculated by the following expression.

$$\text{Luminance Uniformity} = \frac{\text{Maximum Luminance}}{\text{Minimum Luminance}} \text{ Horizontal Line}$$

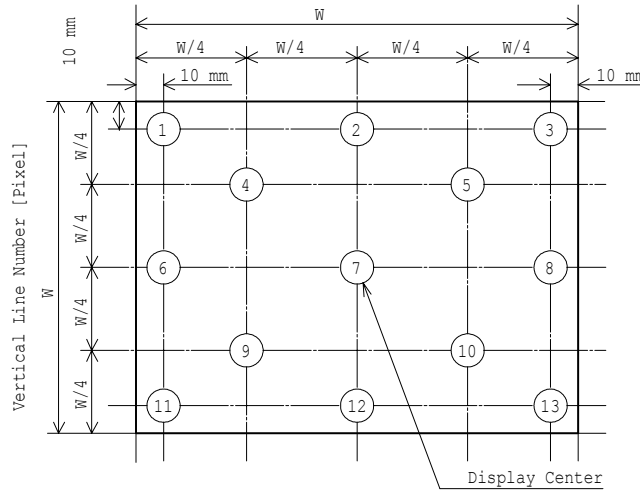

(5) Chromaticity :

The values(x,y) of chromaticity coordinates should be measured for the White, Red, Green and Blue Raster(gray scale level L63) each with a photometer.

(6) Response Time :

The response time (t_{ON} , t_{OFF}) is measured with a photo detector (photodiode) which measures the light intensity of the pixels.

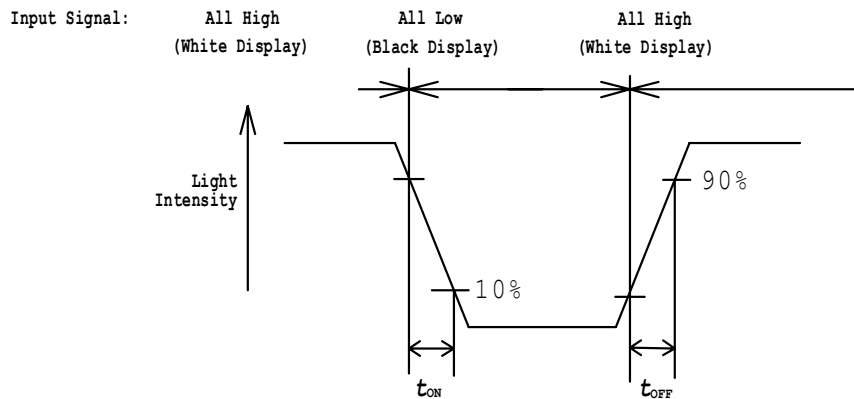

t_{ON} : Turn on time is the time for a photo detector output waveform to go from 90% value to 10% of its maximum.

t_{OFF} : Turn off time is the time for a photo detector output waveform to go from 10% to 90% of its maximum.

Photodiode : S1223-01 HAMAMATSU PHOTONICS K.K.

White Display : White Raster (gray scale level L63)

Black Display : Black Raster (gray scale level L0)

12. EDID

This is the EDID data format to support displays as defined in the VESA Plug & Display.

Header

Byte (dec)	Byte (hex)	Field Name and Comments	Value (hex)	Value (binary)
0	00	Header	00	00000000
1	01	Header	FF	11111111
2	02	Header	FF	11111111
3	03	Header	FF	11111111
4	04	Header	FF	11111111
5	05	Header	FF	11111111
6	06	Header	FF	11111111
7	07	Header	00	00000000

Vendor / Product ID / EDID Version

Byte (dec)	Byte (hex)	Field Name and Comments	Value (hex)	Value (binary)
8	08	EISA manufacture code = 3 Character ID	30	00110000
9	09	EISA manufacture code (Compressed ASCII)	64	00011010
10	0A	Panel Supplier Reserved – Product Code	EB	11101011
11	0B	Panel Supplier Reserved – Product Code	58	01011000
12	0C	LCD module Serial No - Preferred but Optional (“0” if not used)	01	00000001
13	0D	LCD module Serial No - Preferred but Optional (“0” if not used)	01	00000001
14	0E	LCD module Serial No - Preferred but Optional (“0” if not used)	01	00000001
15	0F	LCD module Serial No - Preferred but Optional (“0” if not used)	01	00000001
16	10	Week of manufacture		Value
17	11	Year of manufacture		Value
18	12	EDID structure version # =	01	00000001
19	13	EDID revision # =	03	00000011

Display Parameters

Byte (dec)	Byte (hex)	Field Name and Comments	Value (hex)	Value (binary)
20	14	Video I/P definition = Digital I/P (80h)	80	10000000
21	15	Max H image size = (Rounded to cm)	1A	00011010
22	16	Max V image size = (Rounded to cm)	10	00010000
23	17	Display gamma = (gamma ×100)-100 = Example: (2.2 × 100) – 100 = 120	78	01111000
24	18	Feature support (no DPMS, Active off, RGB, timing BLK 1)	0A	00001010

Panel Color Coordinates

Byte (dec)	Byte (hex)	Field Name and Comments	Value (hex)	Value (binary)
25	19	Red/Green Low bit (RxRy/GxGy)	87	10000111
26	1A	Blue/White Low bit (BxBY/WxWy)	AE	10101110
27	1B	Red X	99	10011001
28	1C	Red Y	57	01010111
29	1D	Green X	4F	01001111
30	1E	Green Y	8C	10001100
31	1F	Blue X	26	00100110
32	20	Blue Y	22	00100010
33	21	White X	50	01010000
34	22	White Y	54	01010100

Established Timings

Byte (dec)	Byte (hex)	Field Name and Comments	Value (hex)	Value (binary)
35	23	Established timings 1 (00h if not used)	00	00000000
36	24	Established timings 2 (00h if not used)	00	00000000
37	25	Manufacturer's timings (00h if not used)	00	00000000

Standard Timing ID

Byte (dec)	Byte (hex)	Field Name and Comments	Value (hex)	Value (binary)
38	26	Standard timing ID1 (01h if not used)	01	00000001
39	27	Standard timing ID1 (01h if not used)	01	00000001
40	28	Standard timing ID2 (01h if not used)	01	00000001
41	29	Standard timing ID2 (01h if not used)	01	00000001
42	2A	Standard timing ID3 (01h if not used)	01	00000001
43	2B	Standard timing ID3 (01h if not used)	01	00000001
44	2C	Standard timing ID4 (01h if not used)	01	00000001
45	2D	Standard timing ID4 (01h if not used)	01	00000001
46	2E	Standard timing ID5 (01h if not used)	01	00000001
47	2F	Standard timing ID5 (01h if not used)	01	00000001
48	30	Standard timing ID6 (01h if not used)	01	00000001
49	31	Standard timing ID6 (01h if not used)	01	00000001
50	32	Standard timing ID7 (01h if not used)	01	00000001
51	33	Standard timing ID7 (01h if not used)	01	00000001
52	34	Standard timing ID8 (01h if not used)	01	00000001
53	35	Standard timing ID8 (01h if not used)	01	00000001

Timing Descriptor #1

Byte (dec)	Byte (hex)	Field Name and Comments	Value (hex)	Value (binary)
54	36	Pixel Clock/10,000 (LSB)	9E	00001110
55	37	Pixel Clock/10,000 (MSB)	20	00100000
56	38	Horizontal Active = xxxx pixels (lower 8 bits) Note	00	00000000
57	39	Horizontal Blanking (Thbp) = xxxx pixels (lower 8 bits)	90	10010000
58	3A	Horizontal Active/Horizontal blanking (Thbp) (upper4:4 bits)	51	01010001
59	3B	Vertical Active = xxxx lines	20	00100000
60	3C	Vertical Blanking (Tvbp) = xxxx lines (DE Blanking min for DE only panels)	1F	00011111
61	3D	Vertical Active : Vertical Blanking (Tvbp) (upper4:4 bits)	30	00110000
62	3E	Horizontal Sync, Offset (Thfp) = xxxx pixels	48	01001000
63	3F	Horizontal Sync, Pulse Width = xxxx pixels	80	10000000
64	40	Vertical Sync, Offset (Tvfp) = xx lines Sync Width = xx lines	36	00110110
65	41	Horizontal Vertical Sync Offset/Width upper 2 bits	00	00000000
66	42	Horizontal Image Size =xxx mm	05	00000101
67	43	Vertical image Size = xxx mm	A3	10100011
68	44	Horizontal Image Size / Vertical image size	10	00010000
69	45	Horizontal Border = 0 (Zero for Notebook LCD)	00	00000000
70	46	Vertical Border = 0 (Zero for Notebook LCD)	00	00000000
71	47	EDID Standard	18	00011110

Timing Descriptor #2 Manufacturer's Specified Range Timing Descriptor

Byte (dec)	Byte (hex)	Field Name and Comments	Value (hex)	Value (binary)
72	48	Header : 00 00 00 0F 00	00	00000000
73	49		00	00000000
74	4A		00	00000000
75	4B		0F	00001111
76	4C		00	00000000
77	4D		Value = $HSPW_{min} / 2$ (pixel clks)	02
78	4E	Value = $HSPW_{max} / 2$ (pixel clks)	D3	11010011
79	4F	Value = $Thbp_{min} / 2$ (pixel clks)	04	00000100
80	50	Value = $Thbp_{max} / 2$ (pixel clks)	D5	11010101
81	51	Value = $VSPW_{min} / 2$ (line pulses)	00	00000000
82	52	Value = $VSPW_{max} / 2$ (line pulses)	17	00010111
83	53	Value = $Tvbp_{min} / 2$ (line pulses)	01	00000001
84	54	Value = $Tvbp_{max} / 2$ (line pulses)	18	00011000
85	55	$Thp_{min} = value * 2 + HA_{pixel\ clks}$ (pixel clks) Note	B9	10111001
86	56	$Thp_{max} = value * 2 + HA_{pixel\ clks}$ (pixel clks) Note	D7	11010111
87	57	$Tvp_{min} = value * 2 + VA_{lines}$ (line pulses)	04	00000100
88	58	$Tvp_{max} = value * 2 + VA_{lines}$ (line pulses)	19	00011001
89	59	Module "A" Revision = Example: 00, 01, 02, 03, etc.	00	00000000

Timing Descriptor #3

Byte (dec)	Byte (hex)	Field Name and Comments	Value (hex)	Value (binary)	
90	5A	Model No. Header : 00 00 00 FE 00	00	00000000	
91	5B		00	00000000	
92	5C		00	00000000	
93	5D		Terminator : 0A Blank : 20	FE	11111110
94	5E		00	00000000	
95	5F	T M D I S P L A Y Terminator : 0A Blank : 20	54	01010100	
96	60		4D	01001101	
97	61		44	01000100	
98	62		49	01001001	
99	63		53	01010011	
100	64		50	01010000	
101	65		4C	01001100	
102	66		41	01000001	
103	67		59	01011001	
104	68	0A	00001010		
105	69	20	00100000		
106	6A	20	00100000		
107	6B	20	00100000		

Timing Descriptor #4

Byte (dec)	Byte (hex)	Field Name and Comments	Value (hex)	Value (binary)
108	6C	Module Serial Header : 00 00 00 FE 00 Terminator : 0A Blank : 20	00	00000000
109	6D		00	00000000
110	6E		00	00000000
111	6F		FE	11111111
112	70		00	00000000
113	71	L Product Name: T D 1 2 1 E X V V Terminator : 0A Blank : 20	4C	01001100
114	72		54	01010100
115	73		44	01000100
116	74		31	00110001
117	75		32	00110010
118	76		31	00110001
119	77		45	01000101
120	78		58	01011000
121	79		56	01010110
122	7A		56	01010110
123	7B	0A	00001010	
124	7C	20	00100000	
125	7D	20	00100000	

Byte (dec)	Byte (hex)	Field Name and Comments	Value (hex)	Value (binary)
126	7E	Extension flag (# of optional 128 EDID extension blocks to follow, Typ = 0)	00	00000000
127	7F	Checksum (The 1-byte sum of all 128 bytes in this EDID block shall = 0)	-	-

EDID Notes:

<EEPROM address>

Devise Address Read : A1h
 Write : A0h