



ELECTRONICS

Approval

TO : General
DATE : March 21, 2003

SAMSUNG TFT-LCD
MODEL NO.: LTN150XB-L03



Any Modification of Spec is not allowed without SEC permission

APPROVED BY : *K. H. Shin*

PREPARED BY : **Technical Customer Service Team, AMLCD Division**

SAMSUNG ELECTRONICS CO., LTD.



Doc.No.	LTN150XB-L03	Rev.No	04-A00-G-030321	Page	1 / 24
----------------	--------------	---------------	-----------------	-------------	--------

CONTENTS

Revision History	----- (3)
General Description	----- (4)
1. Absolute Maximum Ratings	----- (5)
1.1 Absolute Ratings of environment	
1.2 Electrical Absolute Ratings	
2. Optical Characteristics	----- (7)
3. Electrical Characteristics	----- (10)
3.1 TFT LCD Module	
3.2 Backlight Unit	
4. Block Diagram	----- (13)
4.1 TFT LCD Module	
4.2 Backlight Unit	
5. Input Terminal Pin Assignment	----- (14)
5.1 Input Signal & Power	
5.2 LVDS Interface	
5.3 Backlight Unit	
5.4 Timing Diagrams of LVDS For Transmitting	
5.5 Input Signals, Basic Display Colors and Gray Scale of Each Color.	
5.6 Pixel format	
6. Interface Timing	----- (19)
6.1 Timing Parameters(DE Mode)	
6.2 Timing Diagrams of interface Signal (DE Mode)	
6.3 Power ON/OFF Sequence	
7. Mechanical Outline Dimension	----- (22)
8. General Precautions	----- (23)

REVISION HISTORY

Approval

Date	Rev.No.	Page	Summary
Feb.13, 2003	000	All	-LTN150XB-L03 model rev.000 specification was First issued.

Doc.No.

LTN150XB-L03

Rev.No

04-A00-G-030321

Page

3 / 24

GENERAL DESCRIPTION

DESCRIPTION

LTN150XB-L03 is a color active matrix TFT (Thin Film Transistor) liquid crystal display (LCD) that uses amorphous silicon TFT as a switching devices. This model is composed of a TFT LCD panel, a driver circuit and a backlight system. The resolution of a 15.0" contains 1,024 x 768 pixels and can display up to 262,144 colors. 6 O'clock direction is the Optimum viewing angle.

FEATURES

- Thin and light weight
- High contrast ratio
- XGA ((1024x768) pixels) resolution
- Low power consumption
- DE (Data enable) only mode.
- 3.3V LVDS (FPD Link) Interface with 1 pixel / clock
- EDID,SPWG-B style

APPLICATIONS

- Notebook PC and desktop monitors
- Display terminals for AV application products
- Monitors for Industrial machine
- If the usage of this product is not for PC application, but for others, please contact SEC

GENERAL INFORMATION

ITEM	SPECIFICATION	UNIT	NOTE
Display area	304.128(H)X228.096(V) (15.0" diagonal)	mm	
Driver element	a-si TFT active matrix		
Display colors	262,144		
Number of pixel	1024 x 768	pixel	
Pixel arrangement	RGB vertical stripe	mm	
Pixel pitch	0.297(H) x 0.297(V)		
Display Mode	Normally white		
Surface treatment	HAZE 25, HARD-COATING 3H		

Mechanical Information

ITEM		MIN.	TYP.	MAX.	NOTE
Module size	Horizontal (H)	316.8	317.3	317.8	
	Vertical (V)	241.4	242.0	242.6	
	Depth (D)	-	-	6.5	(1)
Weight			585g	605g	

Note (1) Measurement condition of outline dimension
. Equipment : Vernier Calipers
. Push Force : 500g · f (minimum)

1. ABSOLUTE MAXIMUM RATINGS

1.1 ENVIRONMENTAL ABSOLUTE RATINGS

ITEM	SYMBOL	MIN.	MAX.	UNIT	NOTE
Storage temperate	T_{STG}	-25	60	°C	(1)
Operating temperate (Temperature of glass surface)	T_{OPR}	0	50	°C	(1)
Shock (non-operating)	Snop	-	220	G	(2), (4)
Vibration (non-operating)	Vnop	-	1.5	G	(3), (4)

Note (1) Temperature and relative humidity range are shown in the figure below.

95 % RH Max. (40 °C T_a)

Maximum wet - bulb temperature at 39 °C or less. ($T_a > 40$ °C) No condensation.

(2) 2ms, half sine wave, one time for $\pm X, \pm Y, \pm Z$.

(3) 10 300 10 Hz, Sweep rate 10 min, 30 min for X,Y,Z.

(4) At testing Vibration and Shock, the fixture in holding the Module to be tested have to be hard and rigid enough so that the Module would not be twisted or bent by the fixture.

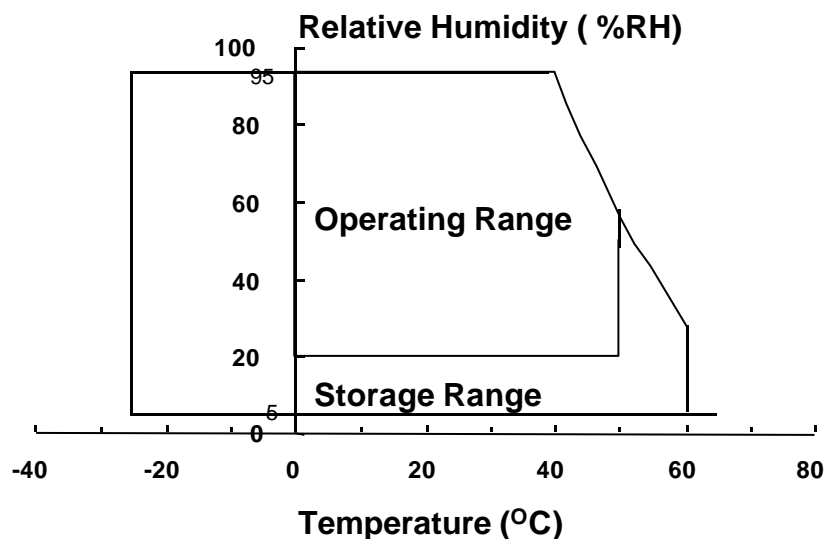

1.2 ELECTRICAL ABSOLUTE RATINGS

(1) TFT LCD MODULE

(V_{SS} = GND = 0 V)

ITEM	SYMBOL	MIN.	MAX.	UNIT	NOTE
Power Supply Voltage	V _{CC}	V _{SS} -0.3	4.0	V	(1)
Logic Input Voltage	V _{IN}	V _{SS} -0.3	V _{CC} + 0.3	V	(1)

NOTE (1) Within Ta (25 ± 2 °C)

(2) BACK-LIGHT UNIT

Ta = 25 ± 2 °C

ITEM	SYMBOL	MIN.	MAX.	UNIT.	NOTE
Lamp current	I _L	2.0	7.0	mA _{RMS}	(1)
Lamp frequency	F _L	50	80	KHz	(1)

NOTE (1) Permanent damage to the device may occur if maximum values are exceeded.
Functional operation should be restricted to the conditions described under Normal Operating Conditions.

2. OPTICAL CHARACTERISTICS

The following items are measured under stable conditions. The optical characteristics should be measured in a dark room or equivalent state with the methods shown in Note (5).

Measuring equipment : TOPCON BM-5A

* $T_a = 25 \pm 2^\circ\text{C}$, $V_{cc}=3.3\text{V}$, $f_v=60\text{Hz}$, $f_{dCLK}=65\text{MHz}$, $I_L=6.0\text{mA}$

ITEM	SYMBOL	CONDITION	MIN.	TYP.	MAX.	UNIT	NOTE
Contrast Ratio (5 Points)	CR		200	-	-		
Response Time at 25	Rising	T_R	-	10	20	msec	(1), (3)
	Falling	T_F	-	30	40		
Luminance of White	Y_L		-	160	-	cd/m ²	(1), (4)
Color Chromaticity (CIE)	Red	R_X	$\phi = 0,$ $\theta = 0$ Normal Viewing Angle	0.546	0.576	0.606	(1), (5)
		R_Y		0.311	0.341	0.371	
	Green	G_X		0.293	0.323	0.353	
		G_Y		0.502	0.532	0.562	
	Blue	B_X		0.123	0.153	0.183	
		B_Y		0.102	0.132	0.162	
	White	W_X		0.283	0.313	0.343	
		W_Y		0.299	0.329	0.359	
Viewing Angle	Hor.	θ_L	CR 10 (at center point)	40	45	-	Degrees
		θ_R		40	45	-	
	Ver.	ϕ_H		20	25	-	
		ϕ_L		40	45	-	
13 Points White Variation	L		-	-	1.65		(6)

Note 1) Definition of Viewing Angle :

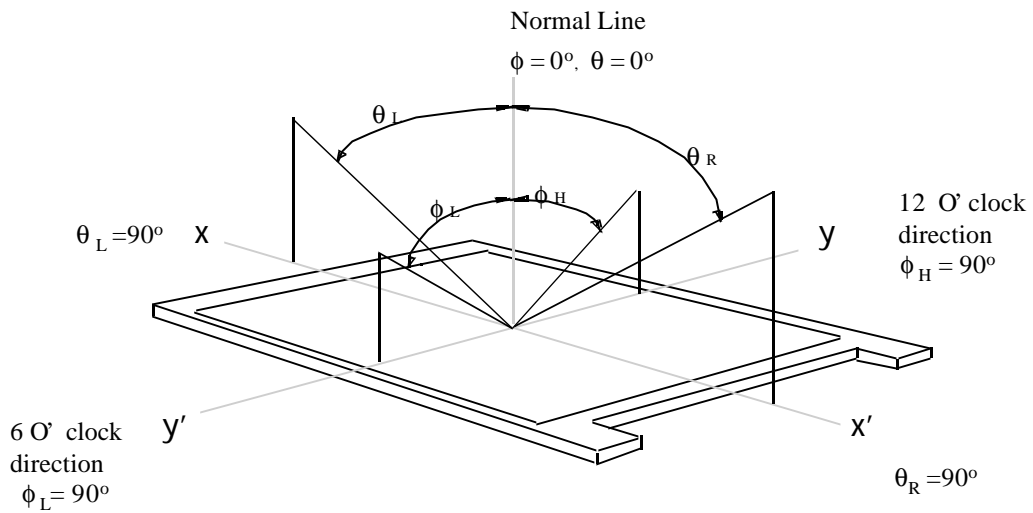

Note 2) Definition of Contrast Ratio (CR) :

$$CR = \frac{CR1 + CR2 + CR3 + CR4 + CR5}{5}$$

POINTS : (4) , (5) , (7) , (9) , (10) at FIGURE OF NOTE 6)

Note 3) Definition of Response time :

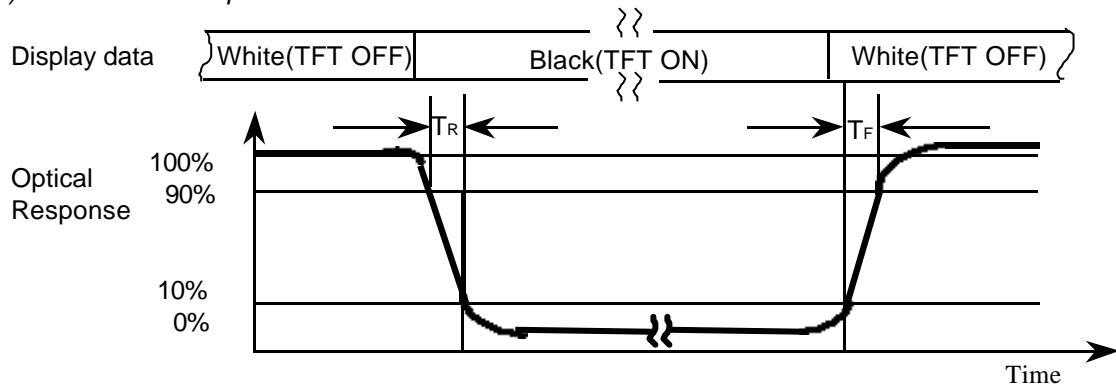

Note 4) Definition of Average Luminance of White : measure the luminance of white at 5 points.

Average Luminance of White ($Y_{L,AVE}$)

$$Y_{L,AVE} = \frac{Y_{L4} + Y_{L5} + Y_{L7} + Y_{L9} + Y_{L10}}{5}$$

POINTS : (4) , (5) , (7) , (9) , (10) at FIGURE OF NOTE 6)

Note 5) After stabilizing and leaving the panel alone at a given temperature for 30 minutes, the measurement should be executed. Measurement should be executed in a stable, windless, and dark room. 30 minutes after lighting the back-light. This should be measured in the center of screen.
 Lamp current : 6.0 mA
 Environment condition : $T_a = 25 \pm 2 \text{ }^\circ\text{C}$

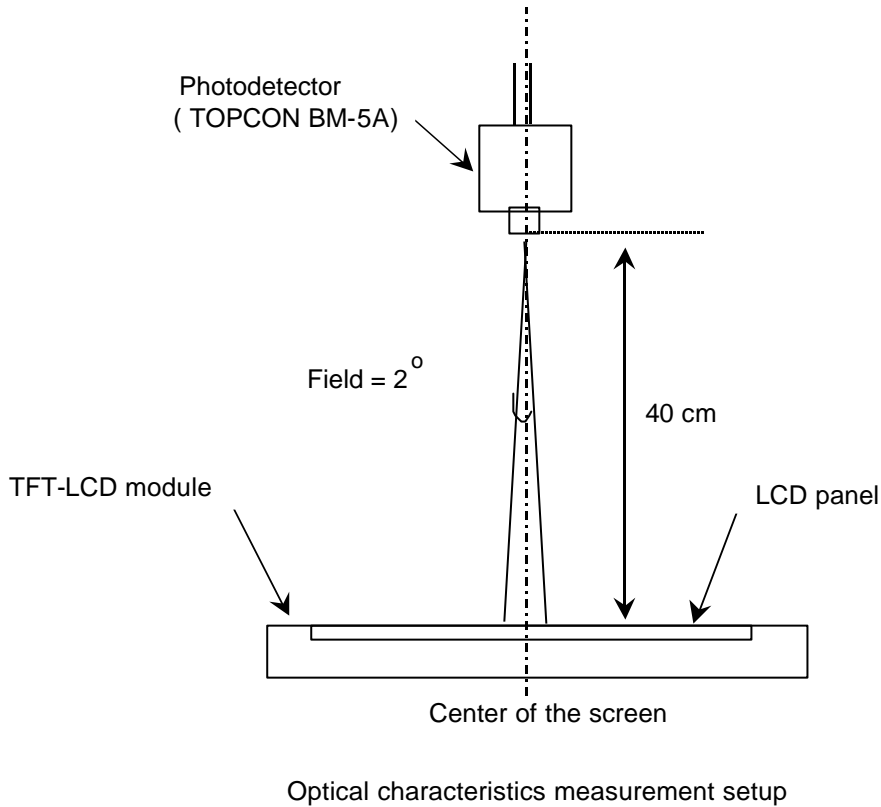

Note 6) Definition of 13 points white variation (d_w), CR variation (C_{VER}) [① ~ ⑬]

$$\delta L = \frac{\text{Maximum luminance of 13 points}}{\text{Minimum luminance of 13 points}} \quad \delta C_R = \frac{\text{Maximum CR of 13 points}}{\text{Minimum CR of 13 points}}$$

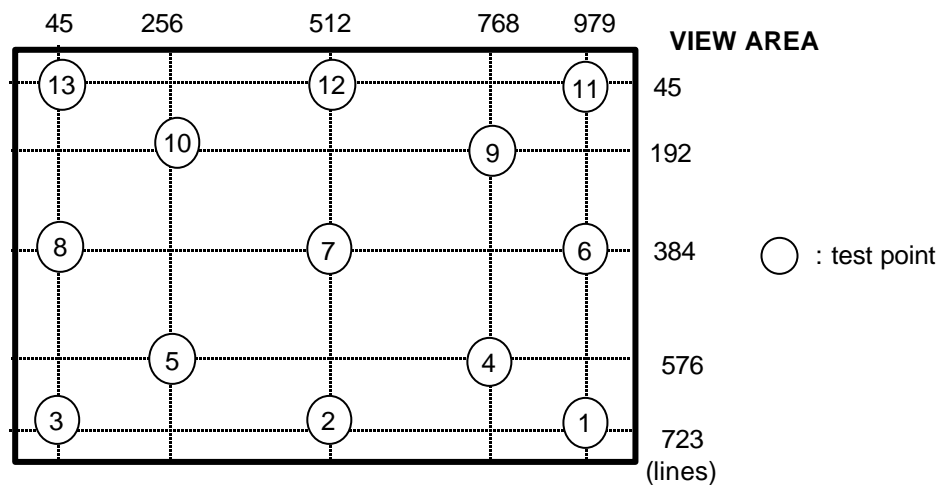

3. ELECTRICAL CHARACTERISTICS

Approval

3.1 TFT LCD MODULE

Ta=25 ± 2 °C

ITEM	SYMBOL	MIN	TYP	MAX	UNIT	NOTE	
Voltage of Power Supply	V _{DD}	3.0	3.3	3.6	V		
Differential Input Voltage for LVDS Receiver Threshold	High	V _{IH}	-	-	+100	mV	V _{CM} =+1.2V
	Low	V _{IL}	-100	-	-	mV	
Vsync Frequency	f _V	-	60	-	Hz		
Hsync Frequency	f _H	-	48.2	-	KHz		
Main Frequency	f _{DCLK}	63.4	65	66.6	MHz		
Rush Current	I _{RUSH}	-	-	1.5	A	(4)	
Current of Power Supply	White	I _{DD}	-	330	-	mA	(2),(3)*a
	Mosaic		-	480	-	mA	(2),(3)*b
	Max Pattern		-	450	500	mA	(2),(3)*c

Note (1) Display data pins and timing signal pins should be connected.(GND=0V)

(2) f_V=60Hz, f_{DCLK}=65MHz, V_{DD} = 3.3V , DC Current.

(3) Power dissipation pattern

*a) White Pattern

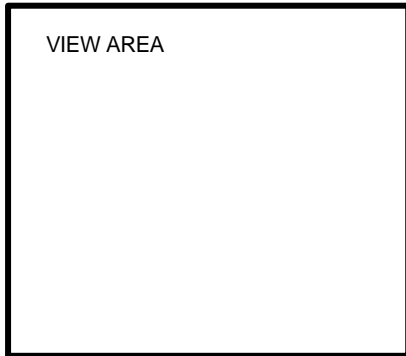

*b) Mosaic Pattern

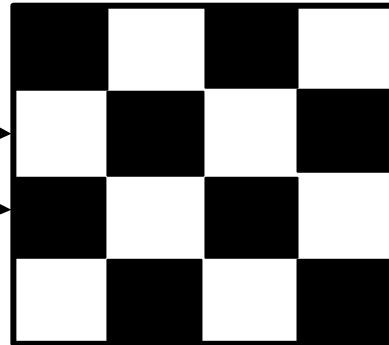

*c) Max. pattern : Vertical stripe.

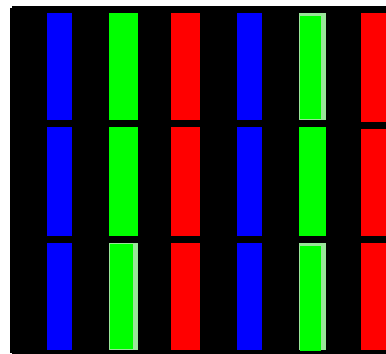
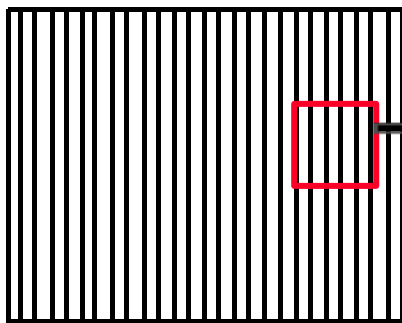

4) Rush current measurement condition

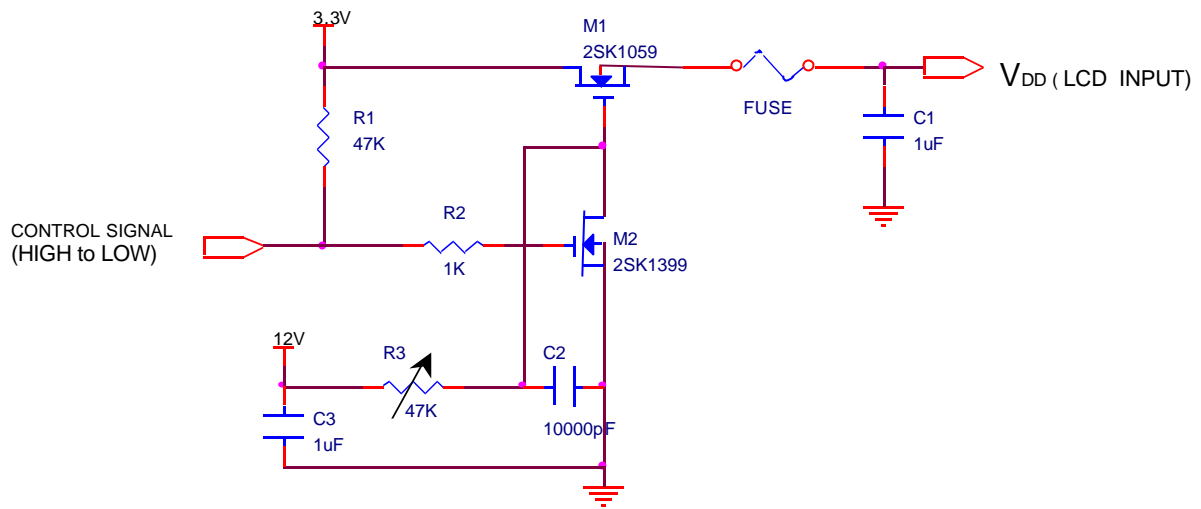

V_{DD} rising time is 470us

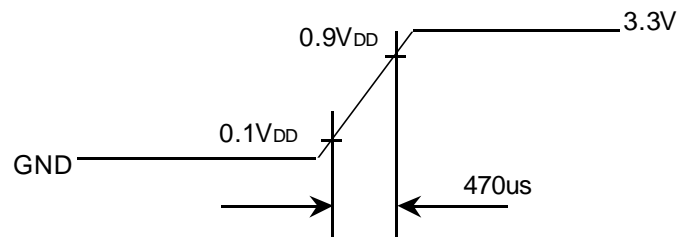

3.2 BACK-LIGHT UNIT

The backlight system is an edge - lighting type with a single CCFL (Cold Cathode Fluorescent Lamp).
The characteristics of a single lamp are shown in the following tables.

INVERTER : SEM SIC130T

LAMP : Sanken P/N: SS20D3095N6370C2852800

Ta=25 ± 2 °C

ITEM	SYMB	MIN	TYP	MAX	UNIT	NOTE
Lamp Current	I _L	3.0	6.0	6.5	mArms	(1)
Lamp Voltage	V _L		710		V _{rms}	I _L =6.0mA
Frequency	f _L	50	60	65	kHz	(2)
Power Consumption	P _L	-	4.26	-	W	(3)
Operating Life Time	Hr	10,000	-	-	Hour	(4)
Startup Voltage	V _s	-	-	1200 (25°C)	V _{rms}	(5)
				1400 (0 °C)		

Note) The waveform of the inverter output voltage must be area symmetric and the design of the inverter must have specifications for the modularized lamp.

The performance of the backlight, for example life time or brightness, is much influenced by the characteristics of the DC-AC inverter for the lamp. So all the parameters of an inverter should be carefully designed so as not to produce too much leakage current from high-voltage output of the inverter.

When you design or order the inverter, please make sure that a poor lighting caused by the mismatch of the backlight and the inverter(miss lighting, flicker, etc.) never occur. When you confirm it, the module should be operated in the same condition as it is installed in your instrument.

Note (1) Lamp current is measured with a high frequency current meter as shown below.

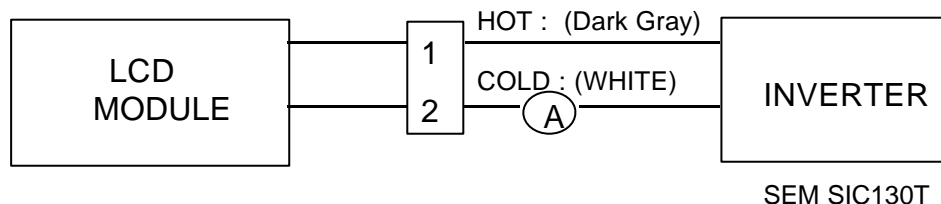

Switching Frequency : 50 ~ 65KHz

(2) Lamp frequency may produce interference with horizontal synchronous frequency and this may cause line flow on the display. Therefore lamp frequency should be detached from the horizontal synchronous frequency and its harmonics as far as possible in order to avoid interference.

(3) refer to I_L × V_L to calculate.

(4) Life time (Hr) of a lamp can be defined as the time in which it continues to operate under the condition Ta = 25 ± 2 °C and I_L = 6.0 mArms until one of the following event occurs.

1. When the brightness becomes 50% or lower than the original.

(5) The voltage above this value should be applied to the lamp for more than 1 second to startup. Otherwise the lamp may not be turned on.

4. BLOCK DIAGRAM

4.1 TFT LCD Module

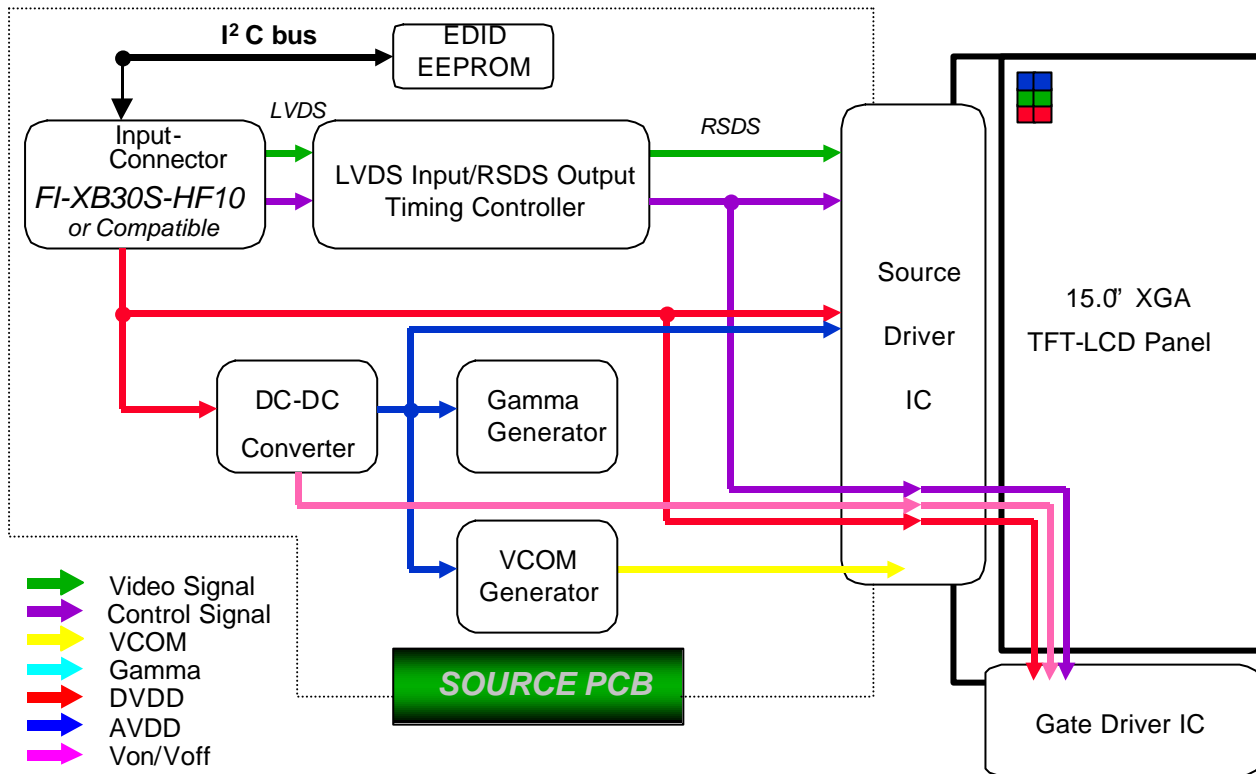

4.2 BACK-LIGHT UNIT

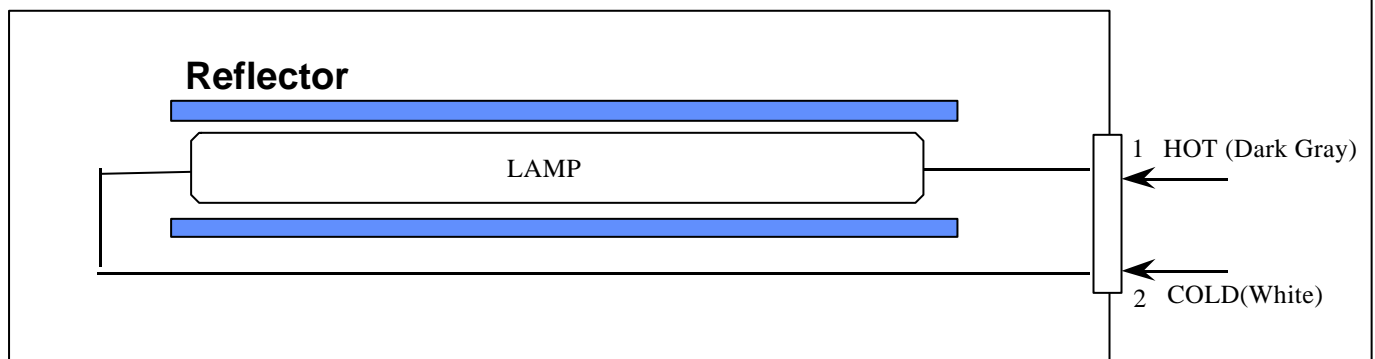

Note) The output of the inverter may change according to the material of the reflector.

5. INPUT TERMINAL PIN ASSIGNMENT

5.1. Input Signal & Power LVDS, Connector : (JAE, FI-XB30S-HF10)
Mating Connector : (JAE FI-X30M)

PIN NO	SYMBOL	FUNCTION	POLARITY	REMARK
1	Vss	Ground		
2	VDD	POWER SUPPLY +3.3V		
3	VDD	POWER SUPPLY +3.3V		
4	VEEDID	DDC 3.3V Power		
5	NC	Reserved for supplier test point		
6	CLKEDID	DDC Clock		
7	DATAEDID	DDC data		
8	O_RxIN0-	LVDS Differential Data INPUT (Odd R0-R5,G0)	Negative	
9	O_RxIN0+	LVDS Differential Data INPUT (Odd R0-R5,G0)	Positive	
10	GND	Ground		
11	O_RxIN1-	LVDS Differential Data INPUT (Odd G1-G5,B0-B1)	Negative	
12	O_RxIN1+	LVDS Differential Data INPUT (Odd G1-G5,B0-B1)	Positive	
13	GND	Ground		
14	O_RxIN2-	LVDS Differential Data INPUT (Odd B1-B5,Sync,DE)	Negative	
15	O_RxIN2+	LVDS Differential Data INPUT (Odd B1-B5,Sync,DE)	Positive	
16	GND	Ground		
17	O_RxCLK-	LVDS Differential Data INPUT (Odd Clock)	Negative	
18	O_RxCLK+	LVDS Differential Data INPUT (Odd Clock)	Positive	
19	GND	Ground		
20	NC	NC		
21	NC	NC		
22	GND	Ground		
23	NC	NC		
24	NC	NC		
25	GND	Ground		
26	NC	NC		
27	NC	NC		
28	GND	Ground		
29	NC	NC		
30	NC	NC		

5.2 LVDS Transmitter : DS90CF383 (National Semiconductor) or Compatible

Pin No.	Name	RGB Signal	Pin No.	Name	RGB Signal
51	TxIN0	R0	14	TxIN14	G5
52	TxIN1	R1	15	TxIN15	B0
54	TxIN2	R2	19	TxIN18	B1
55	TxIN3	R3	20	TxIN19	B2
56	TxIN4	R4	22	TxIN20	B3
3	TxIN6	R5	23	TxIN21	B4
4	TxIN7	G0	24	TxIN22	B5
6	TxIN8	G1	27	TxIN24	Hsync
7	TxIN9	G2	28	TxIN25	Vsync
11	TxIN12	G3	30	TxIN26	DE
12	TxIN13	G4	31	TxCLKIN	Clock

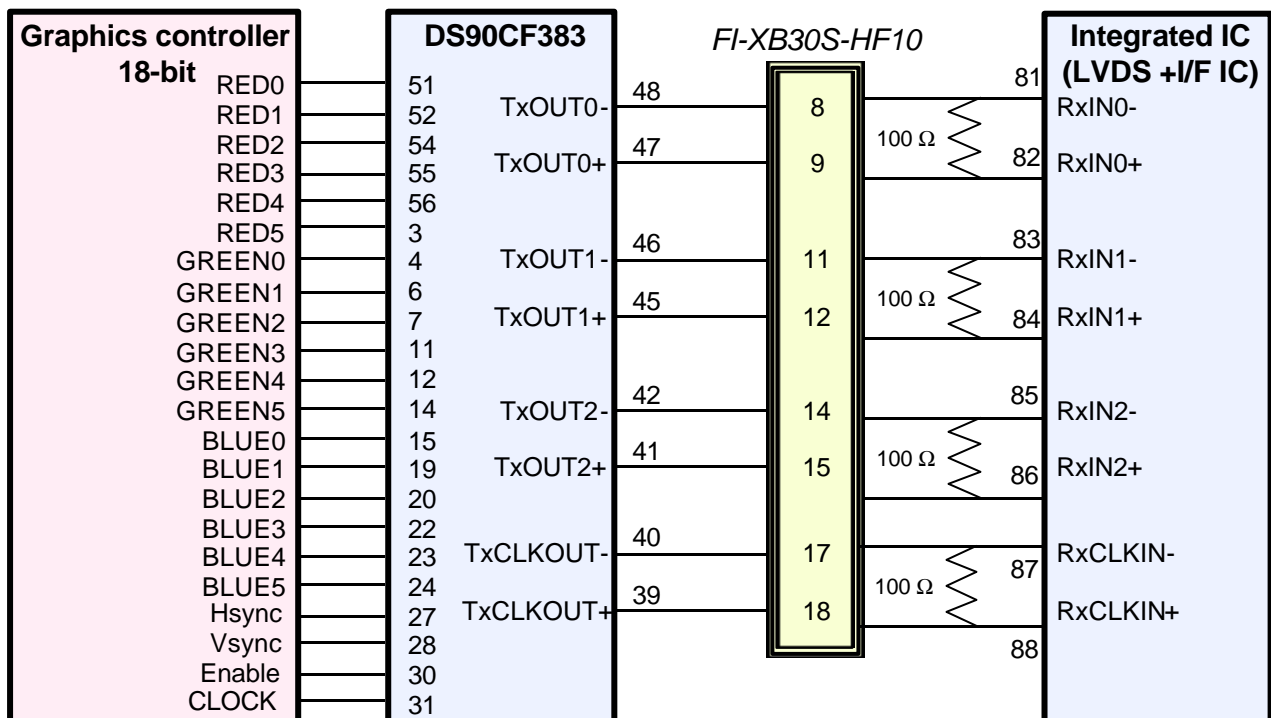
FLAT LINK INTERFACE

Note : The LCD Module uses a 100ohm resistor between positive and negative lines of each receiver input.

5.3 BACK LIGHT UNIT

Connector : JST BHSR - 02VS -1

Pin NO.	Symbol	Color	Function
1	HOT	Dark Gray	High Voltage
2	COLD	White	Ground

5.4 Timing Diagrams of LVDS For Transmission

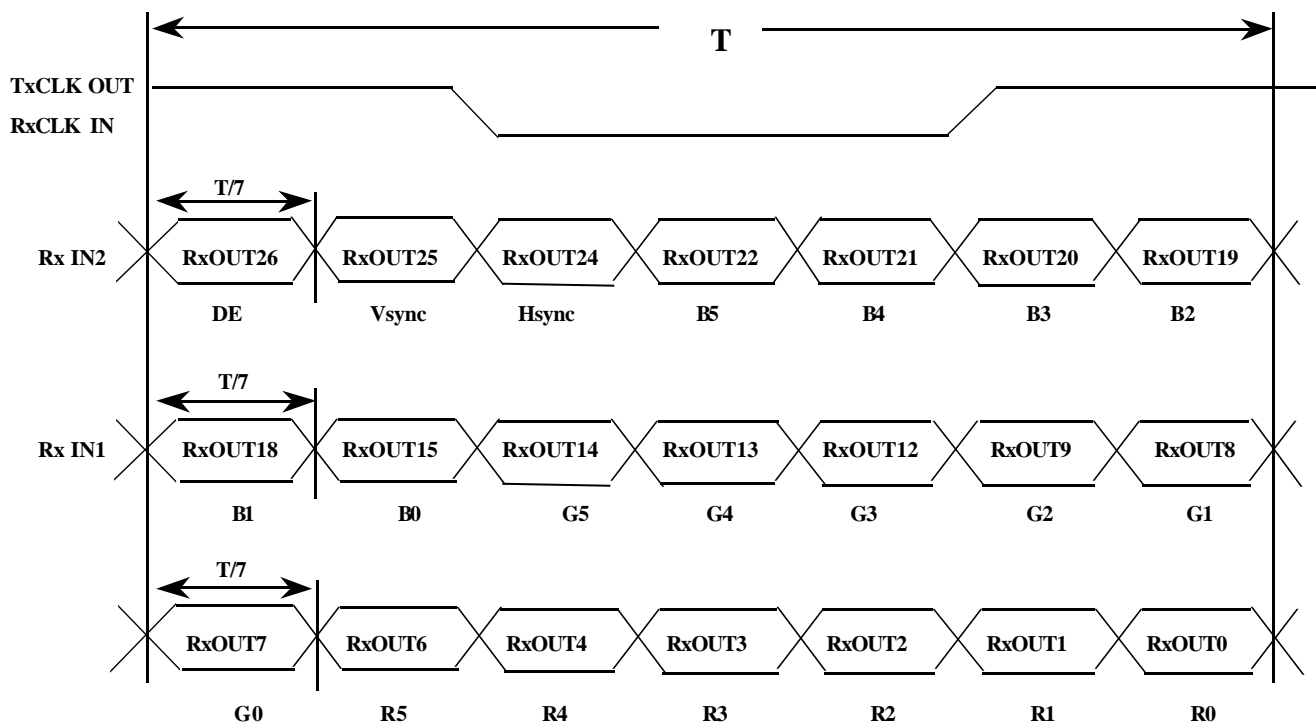

5.5 Input Signals, Basic Display Colors and Gray Scale of Each Color

Approval

COLOR	DISPLAY	DATA SIGNAL																GRAY SCALE LEVEL		
		RED					GREEN					BLUE								
		R0	R1	R2	R3	R4	R5	G0	G1	G2	G3	G4	G5	B0	B1	B2	B3		B4	B5
COLOR	BLACK	0	0	0	0	0	0	0	0	0	0	0	0	0	0	0	0	0	0	-
	BLUE	0	0	0	0	0	0	0	0	0	0	0	0	1	1	1	1	1	1	-
	GREEN	0	0	0	0	0	0	1	1	1	1	1	1	0	0	0	0	0	0	-
	CYAN	0	0	0	0	0	0	1	1	1	1	1	1	1	1	1	1	1	1	-
	RED	1	1	1	1	1	1	0	0	0	0	0	0	0	0	0	0	0	0	-
	MAGENTA	1	1	1	1	1	1	0	0	0	0	0	0	1	1	1	1	1	1	-
	YELLOW	1	1	1	1	1	1	1	1	1	1	1	1	0	0	0	0	0	0	-
	WHITE	1	1	1	1	1	1	1	1	1	1	1	1	1	1	1	1	1	1	-
GRAY SCALE OF RED	BLACK	0	0	0	0	0	0	0	0	0	0	0	0	0	0	0	0	0	0	R0
	DARK ↑	1	0	0	0	0	0	0	0	0	0	0	0	0	0	0	0	0	0	R1
		0	1	0	0	0	0	0	0	0	0	0	0	0	0	0	0	0	0	R2
		:	:	:	:	:	:	:	:	:	:	:	:	:	:	:	:	:	:	R3~R60
		:	:	:	:	:	:	:	:	:	:	:	:	:	:	:	:	:	:	
	↓ LIGHT	1	0	1	1	1	1	0	0	0	0	0	0	0	0	0	0	0	0	R61
		0	1	1	1	1	1	0	0	0	0	0	0	0	0	0	0	0	0	R62
	RED	1	1	1	1	1	1	0	0	0	0	0	0	0	0	0	0	0	0	R63
GRAY SCALE OF GREEN	BLACK	0	0	0	0	0	0	0	0	0	0	0	0	0	0	0	0	0	0	G0
	DARK ↑	0	0	0	0	0	0	1	0	0	0	0	0	0	0	0	0	0	0	G1
		0	0	0	0	0	0	0	1	0	0	0	0	0	0	0	0	0	0	G2
		:	:	:	:	:	:	:	:	:	:	:	:	:	:	:	:	:	:	G3~G60
		:	:	:	:	:	:	:	:	:	:	:	:	:	:	:	:	:	:	
	↓ LIGHT	0	0	0	0	0	0	1	0	1	1	1	1	0	0	0	0	0	0	G61
		0	0	0	0	0	0	0	1	1	1	1	1	0	0	0	0	0	0	G62
	GREEN	0	0	0	0	0	0	1	1	1	1	1	1	0	0	0	0	0	0	G63
GRAY SCALE OF BLUE	BLACK	0	0	0	0	0	0	0	0	0	0	0	0	0	0	0	0	0	0	B0
	DARK ↑	0	0	0	0	0	0	0	0	0	0	0	0	1	0	0	0	0	0	B1
		0	0	0	0	0	0	0	0	0	0	0	0	0	1	0	0	0	0	B2
		:	:	:	:	:	:	:	:	:	:	:	:	:	:	:	:	:	:	B3~B60
		:	:	:	:	:	:	:	:	:	:	:	:	:	:	:	:	:	:	
	↓ LIGHT	0	0	0	0	0	0	0	0	0	0	0	0	1	0	1	1	1	1	B61
		0	0	0	0	0	0	0	0	0	0	0	0	0	1	1	1	1	1	B62
	GREEN	0	0	0	0	0	0	0	0	0	0	0	0	1	1	1	1	1	1	B63

Note 1) Definition of gray :
 Rn: Red gray, Gn: Green gray, Bn: Blue gray (n=gray level)
 Note 2) Input signal: 0 =Low level voltage, 1=High level voltage

5.6 Pixel Format in the display

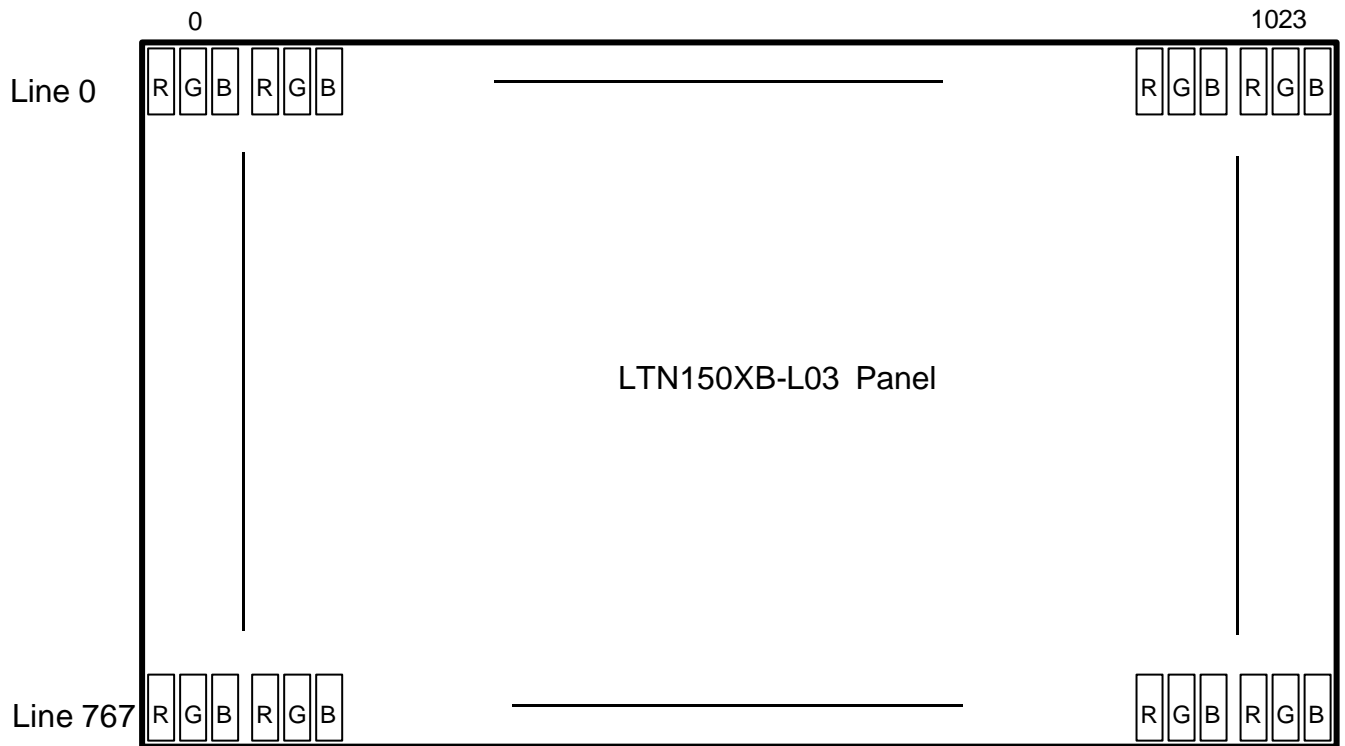

6. INTERFACE TIMING

6.1 Timing Parameters

Signal	Item	Symbol	MIN	TYP	MAX	Unit	Note
Frame Frequency	Cycle	T_V	-	806	-	lines	
Vertical Active Display Term	Display Period	T_{VD}	-	768	-	lines	
One Line Scanning Time	Cycle	T_H	-	1344	-	clocks	
Horizontal Active Display Term	Display Period	T_{HD}	-	1024	-	clocks	
Horizontal Back Porch		T_{hbp}	-	320	-	clocks	
Horizontal front Porch		T_{hfp}	-	24	-	clocks	
Vertical Back Porch		T_{vbp}	-	38	-	lines	
Vertical Front Porch		T_{vfp}	-	3	-	lines	

6.2 Timing diagrams of interface signal

6.2.1 Horizontal Timing

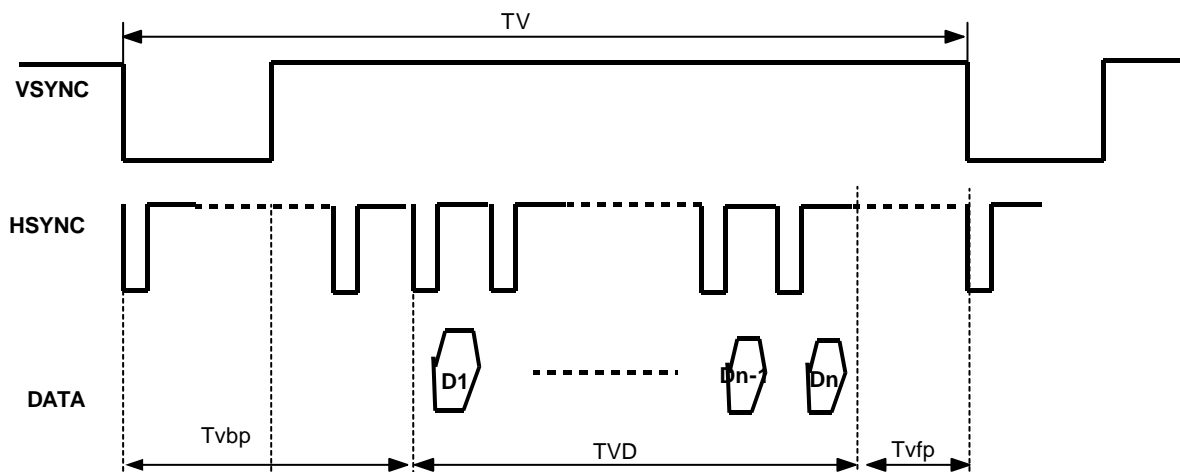

Note : All input conditions(level&timing) are the same with those of LXD01812

6.2.2 Vertical Timing

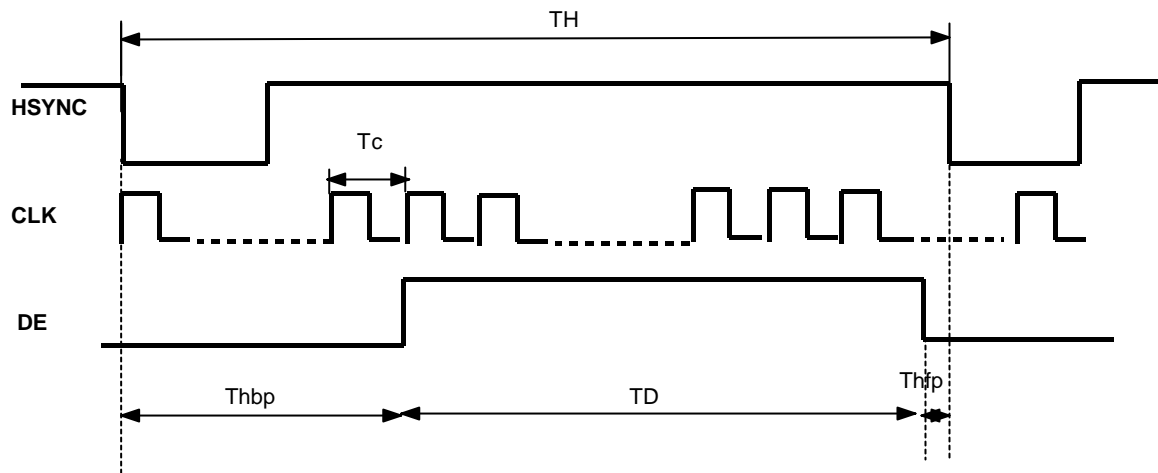

6.3 Power ON/OFF Sequence

: To prevent a latch-up or DC operation of the LCD module, the power on/off sequence shall be as shown below.

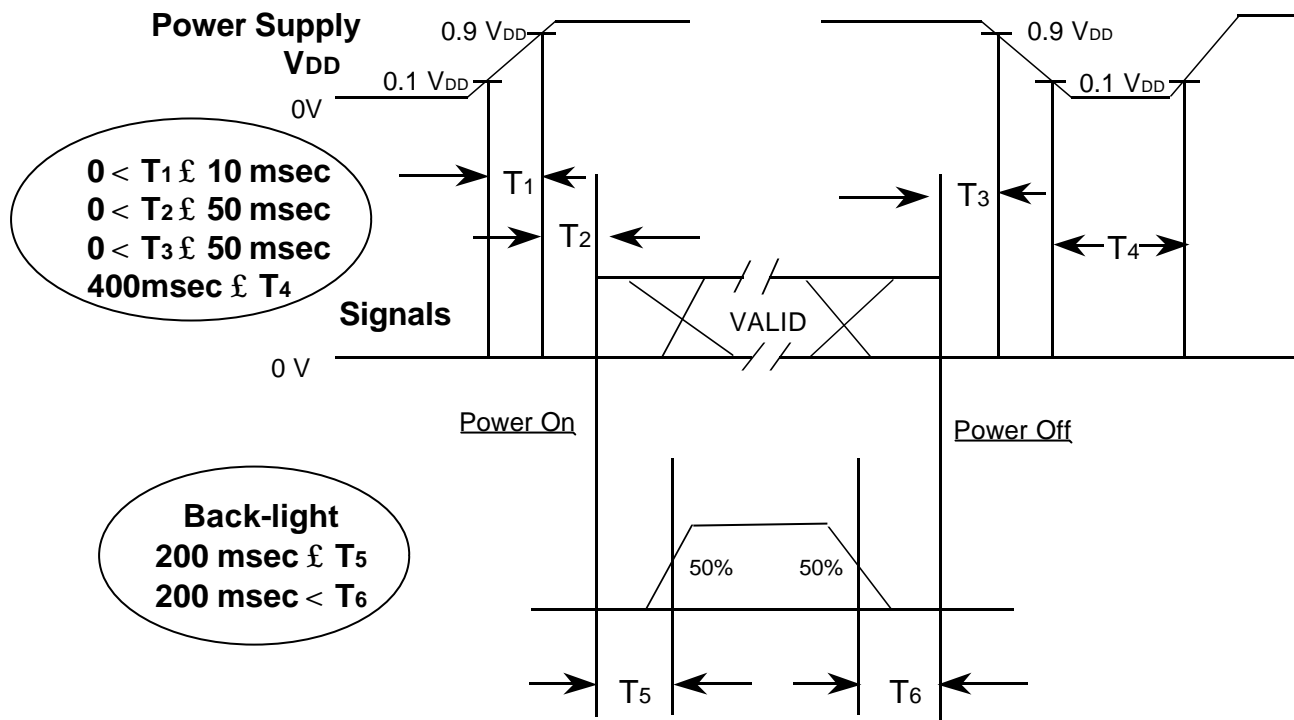

Power ON/OFF Sequence

- T1 : V_{DD} rising time from 10% to 90%
- T2 : The time from V_{DD} to valid data at power ON.
- T3 : The time from valid data off to V_{DD} off at power Off.
- T4 : V_{DD} off time for Windows restart
- T5 : The time from valid data to B/L enable at power ON.
- T6 : The time from valid data off to B/L disable at power Off.

NOTE.

- (1) The supply voltage of the external system for the module input should be the same as the definition of V_{DD}.
- (2) Apply the lamp voltage within the LCD operation range. When the backlight turns on before the LCD operation or the LCD turns off before the backlight turns off, the display may momentarily become white.
- (3) In case of V_{DD} = off level, please keep the level of input signals on the low or keep a high impedance.
- (4) T₄ should be measured after the module has been fully discharged between power off and on period.
- (5) Interface signal shall not be kept at high impedance when the power is on.

7. Mechanical Outline Dimension

Approval

[Refer to the last page]

8. GENERAL PRECAUTIONS

1. Handling

- (a) When the module is assembled, It should be attached to the system firmly using every mounting holes. Be careful not to twist and bend the modules.
- (b) Refrain from strong mechanical shock and / or any force to the module. In addition to damage, this may cause improper operation or damage to the module and CCFT backlight.
- (c) Note that polarizers are very fragile and could be easily damaged. Do not press or scratch the surface harder than a HB pencil lead.
- (d) Wipe off water droplets or oil immediately. If you leave the droplets for a long time, Staining and discoloration may occur.
- (e) If the surface of the polarizer is dirty, clean it using some absorbent cotton or soft cloth.
- (f) The desirable cleaners are water, IPA(Isopropyl Alcohol) or Hexane. Do not use Ketone type materials(ex. Acetone), Ethyl alcohol, Toluene, Ethyl acid or Methyl chloride. It might permanent damage to the polarizer due to chemical reaction.
- (g) If the liquid crystal material leaks from the panel, it should be kept away from the eyes or mouth. In case of contact with hands, legs or clothes, it must be washed away thoroughly with soap.
- (h) Protect the module from static, it may cause damage to the C-MOS Gate Array IC.
- (i) Use fingerstalls with soft gloves in order to keep display clean during the incoming inspection and assembly process.
- (j) Do not disassemble the module.
- (k) Do not pull or fold the lamp wire.
- (l) Do not adjust the variable resistor which is located on the back side.
- (m) Protection film for polarizer on the module shall be slowly peeled off just before use so that the electrostatic charge can be minimized.
- (n) Pins of I/F connector shall not be touched directly with bare hands.

2. STORAGE

- (a) Do not leave the module in high temperature, and high humidity for a long time.
It is highly recommended to store the module with temperature from 0 to 35°C and relative humidity of less than 70%.
- (b) Do not store the TFT-LCD module in direct sunlight.
- (c) The module shall be stored in a dark place. It is prohibited to apply sunlight or fluorescent light during the store.

3. OPERATION

- (a) Do not connect, disconnect the module in the “ Power On” condition.
- (b) Power supply should always be turned on/off by following item 6.3 “ Power on/off sequence “ .
- (c) Module has high frequency circuits. Sufficient suppression to the electromagnetic interference shall be done by system manufacturers. Grounding and shielding methods may be important to minimize the interference.
- (d) The cable between the backlight connector and its inverter power supply shall be a minimized length and be connected directly . The longer cable between the backlight and the inverter may cause lower luminance of lamp(CCFT) and may require higher startup voltage(Vs).

4. OTHERS

- (a) Ultra-violet ray filter is necessary for outdoor operation.
- (b) Avoid condensation of water. It may result in improper operation or disconnection of electrode.
- (c) Do not exceed the absolute maximum rating value. (the supply voltage variation, input voltage variation, variation in part contents and environmental temperature, so on)
Otherwise the module may be damaged.
- (d) If the module displays the same pattern continuously for a long period of time, it can be the situation when the image “ sticks” to the screen.
- (e) This module has its circuitry PCB' s on the rear side and should be handled carefully in order not to be stressed.

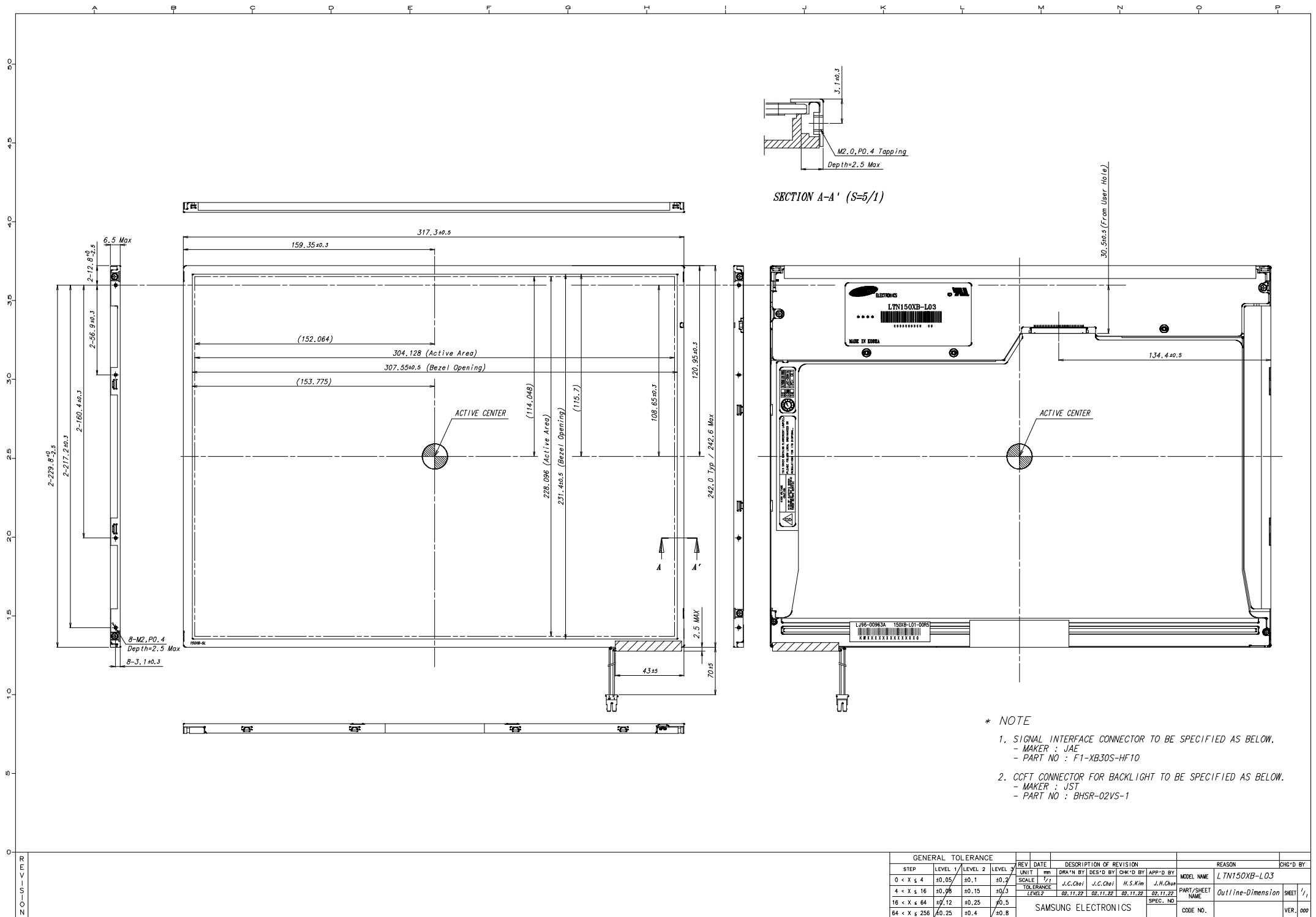

SECTION A-A' (S=5/1)

* NOTE

- SIGNAL INTERFACE CONNECTOR TO BE SPECIFIED AS BELOW.
 - MAKER : JAE
 - PART NO : F1-XB30S-HF10
- COFT CONNECTOR FOR BACKLIGHT TO BE SPECIFIED AS BELOW.
 - MAKER : JST
 - PART NO : BHSR-02VS-1

NO. 0-1-REV

GENERAL TOLERANCE				REV	DATE	DESCRIPTION OF REVISION			REASON	CHK'D BY	
STEP	LEVEL 1	LEVEL 2	LEVEL 3	UNIT	mm	DRAWN BY	DES'D BY	CHK'D BY	APP'D BY	MODEL NAME	
0 < X ≤ 4	±0.05	±0.1	±0.2	SCALE	1/1	J.C.Chei	J.C.Chei	H.S.Kim	J.H.Chun	L TN150XB-L03	
4 < X ≤ 16	±0.08	±0.15	±0.3	TOLERANCE		02.11.22	02.11.22	02.11.22	02.11.22	PART/SHEET NAME	
16 < X ≤ 64	±0.12	±0.25	±0.5							Outline-Dimension	
64 < X ≤ 256	±0.25	±0.4	±0.8							SHEET 1/1	
SAMSUNG ELECTRONICS										CODE NO.	VER. 000