

Product Specification

APPROVAL

- () Preliminary Specification
 () Final Specification

Title	6.4寸 TFT LCD
-------	--------------

BUYER NAME	
MODEL NAME	

SUPPLIER	LG Electronics Inc.
MODEL NAME	LC064N1

SIGNATURE	DATE
_____/_____ 	_____
_____/_____ 	_____
_____/_____ 	_____

APPROVED BY	DATE
_____/G.Manager	_____
REVIEWED BY	
_____/S.Engineer	_____
PREPARED BY	
_____/ Engineer	_____

Please return 1 copy for our confirmation with your signature and comments.

**Product Engineering Dept.
LCD Division LG Electronics Inc.**

Product Specification**CONTENTS**

NO.	ITEM	Page
-	COVER	2
-	RECORD of REVISION	3
1.	GENERAL DESCRIPTION	4
2.	MAXIMUM RATINGS	5
3.	ELECTRICAL SPECIFICATIONS	5
4.	OPTICAL SPECIFICATIONS	6
5.	INTERFACE CONNECTIONS	7
6.	SIGNAL TIMING SPECIFICATIONS	8
7.	SIGNAL TIMING WAVE FORMS	9
8.	MECHANICAL CHARACTERISTICS	10
9.	RELIABILITY TEST	11
10.	HANDLING PRECAUTIONS	13
11.	APPENDIX	14
12.	DRAWING	17

Record of Revision

<p>September. 12. 1997 October. 15. 1997 February. 15. 1998</p>	<p>Preliminary Ver. 1.0 Preliminary Ver. 1.01 Preliminary Ver. 1.02</p>
---	---

Product Specification
1. General Description

The LG Electronics model LC064N1 LCD is a Color Active Matrix Liquid Crystal Display with an integral Cold Cathode Fluorescent Tube (CCFT) back light system. The matrix employs a-Si Thin Film Transistor as the active element. It is a transmissive type display operating in a normally white mode. The active display area of this TFT-LCD is 6.4 inch diagonally and resolution is 468 vertical by 640 horizontal pixel array. Each pixel is divided into Red, Green and Blue sub-pixels or dots which are configured in a stripe arrangement.

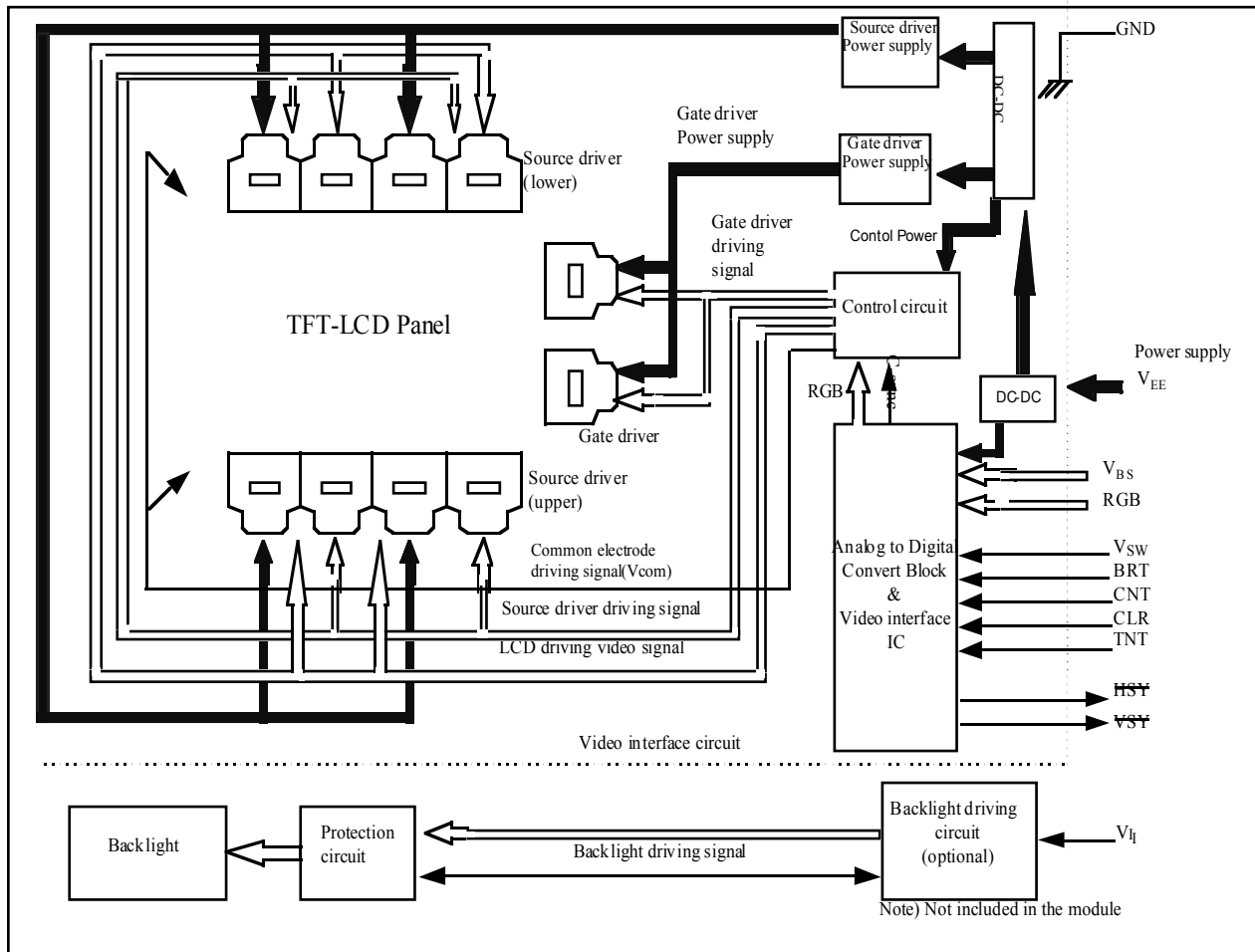
General Display Characteristics

The following are general features of the LC064N1;

Outside dimensions	168.0(W)°d23.0(H)°d5.5(D) mm
Active display area	163.2mm (6.42 Inches) diagonal
Viewing area	161.743mm (6.36Inches) diagonal
Pixel pitch	0.204(H)mm°0.204(V) mm
Pixel format	640 horiz. by 468 vert. pixels
	RGB stripe arrangement
Color depth	262,144 color
Display operating mode	Transmissive mode, normally white
Surface treatments	Low-reflection treatment of C/F (CrO _x coating)
Power consumption	5 Watts (Exclude external inverter)

2. Maximum Ratings

The following are maximum values which, if exceeded, may cause faulty operation or damage to the unit.

Product Specification
Table 1 ABSOLUTE MAXIMUM RATINGS

Parameter		symbol	Values		Units	Notes
			Min.	Max.		
DC power	Positive power	V_{EE}	-0.3	14.0	V	
Analog RGB	Composite video	V_{BS}		3.0	V_{p-p}	
	Analog RGB	V_{RI}, V_{GI}, V_{BI}	-0.3	5.3	V_{p-p}	
	Digital signal	HSY, VSY, V_{SW}	-0.3	5.3	V	
	Control signal	BRT, CNT, CLR, TNT	-0.3	4.7	V	
	Operating Temperature	T_{OP}	0	50	°...	1)
	Storage Temperature	T_{ST}	-20	60	°...	2)

Note : 1) Relative Humidity is 0 %

2) Under no condition should the unit be exposed to corrosive chemicals.

3. Electrical Specifications

The LC064N1 requires two power inputs. One is employed to power the LCD module and to derive the voltages that drive the TFT array and liquid crystal. The second input which powers the back-light CCFT, is typically generated by an inverter which is an external unit from the LCD.

Table 2 ELECTRICAL CHARACTERISTICS:

Parameter			Symbol	Values			Units	Impedance	
				Min.	Typ.	Max.			
MODULE	DC Power	Positive power	V_{EE}	10.8	12.0	13.2	V		
	Analog signal	Composite video	Amplitude	V_{BS}	0.8	1.0	1.2	V_{p-p}	$75 \cdot \dot{y}$ $>0.2 V_{p-p}^{1)}$
		Analog RGB	Amplitude	V_{RI} V_{GI} V_{BI}	-	0.7	2.0	V_{p-p}	$>10k \cdot \dot{y}$
	Digital signal	Input	High	V_{SW}	3.5	-	5.0	V	$>50k \cdot \dot{y}$
			Low		0.0	-	1.5	V	
		Output	High	HSY	3.5	-	5.0	V	$>20k \cdot \dot{y}$
			Low	VSY	0.0	-	1.5	V	
		Power consumption		P_c	-	2.94	3.12	watts	Exclude Lamp
BACK-LIGHT	Lamp Input voltage		V_{LI}	300	355	385-	V_{RMS}		
	Lamp Input current		I_{LI}	3	5	9	mA		
	Lamp kick-off Voltage		V_{LK}	-	-	860(0°).. 680(25°)..	V_{RMS}		
	Lamp operating Frequency		F_{BL}	35	55	80	kHz		
	Power consumption ²⁾		P_{BL}	1.2	1.8	2.7	watts		

Notes : 1) Amplitude of sync. signal

2) The back-light power consumption shown above excludes an external inverter.

Product Specification

4. Optical Specifications

Optical characteristics are determined after the unit has been 'ON' and stable for approximately 30 minutes in a dark environment at 25°C, 50%RH. The specified values are at an approximate distance 50 cm from the LCD surface at a viewing angle of Φ and θ equal to 0°.

Appendix A presents additional information concerning the specified these characteristics.

Table 3 OPTICAL CHARACTERISTICS

Parameter	Symbol	Values			Units	Notes
		Min.	Typ.	Max.		
Contrast Ratio	CR	50	-	-		1)
Surface Brightness, white	SB _{WH}	100	120	-	cd/m ²	2)
Brightness Uniformity	SB _U	-	-	2.5		3)
Response Time	Tr				msec	4)
Rising Time	Tr _R	-	-	30		
Falling Time	Tr _f	-	-	50		
CIE Color Coordinates						
Red	x _R	0.52	0.55	0.58		
	y _R	0.31	0.34	0.37		
Green	x _G	0.25	0.28	0.31		
	y _G	0.49	0.52	0.55		
Blue	x _B	0.12	0.15	0.18		
	y _B	0.08	0.11	0.14		
White	x _w	0.28	0.31	0.34		
	y _w	0.31	0.34	0.37		
Viewing Angle					degree, °Δ	5)
x axis, right (•≐0°)	•E		45			
x axis, left(•≐180°)	•E		45			
y axis, up(•≐90°)	•E		10			
y axis, down (•≐270°)	•E		30			

Notes : 1) Contrast Ratio (CR) is defined mathematically in window as :

(Surface Brightness with white pixels : 100% IRE)

(Surface Brightness with black pixels : 0 % IRE)

- 2) Surface brightness is a measurement of the active display area, 50cm from the center of the surface in condition of displaying window pattern.
- 3) Brightness uniformity is defined mathematically. For more information see Appendix A.
- 4) Response time is the time required for the display to transition from white to black(Rising Time, Tr_R) and from black to white (Falling Time, Tr_f). For additional information see Appendix A.
- 5) Viewing angle is the angle at which the contrast ratio is greater than 10 with window pattern. The angle are determined for the horizontal or x axis and the vertical y axis with respect to the z axis which is normal to the LCD surface. For more information see Appendix A.
- 6) Optical characteristics are measured using the following equipments;
photometer is PR880(PHOTO RESEARCH), pattern generator is PM5640A (PHILIPS) .

Product Specification

5. Interface Connections

The interface connector is a 28pin, that is manufactured by Elco. (# Model : 6200 - 528 - 430- 000)
 The electronics interface connector is connected to the FFC.
 The pin configuration for the connector is shown in the table below.

Table 4 MODULE CONNECTOR PIN CONFIGURATION

Pin	Symbol	I/O	Description	Notes
1	HSY	O	Internal horizontal sync signal(in phase with V _{BS})	1)
2	VS _Y	O	Internal vertical sync signal(in phase with V _{BS})	1)
3	NC	-	This shall be electrically opened during operation.	
4	NC	-	This shall be electrically opened during operation.	
5	NC	-	This shall be electrically opened during operation.	
6	CLR	I	Color adjusting terminal	2)
7	BRT	I	Brightness adjusting terminal	2)
8	TNT	I	Tint adjusting terminal	2)
9	CNT	I	Contrast adjusting terminal	2)
10	GND	I	Ground	
11	V _{BS}	I	Composite video signal	3)
12	GND	I	Ground	
13	V _{RI}	I	Color video signal(Red)	4)
14	GND	I	Ground	
15	V _{GI}	I	Color video signal(Green)	4)
16	GND	I	Ground	
17	V _{BI}	I	Color video signal(Blue)	4)
18	GND	I	Ground	
19	YS	I	Super impose	5)
20	V _{SW}	I	Selection signal of Composite or Analog R.G.B	6)
21	NC	I	This shall be electrically opened during operation.	
22	CSY	I	Csync input (As a selection of Analog R.G.B signal)	
23	GND	I	Ground	
24	GND	I	Ground	
25	VEE	I	Positive power supply voltage	
26	NC	-	This shall be electrically opened during operation.	
27	NC	-	This shall be electrically opened during operation.	
28	NC	-	This shall be electrically opened during operation.	

Notes: 1) Negative polarity

2) Brightness, contrast, color gain and tint are adjusted by the DC voltage supplied to each pin. (Contrast, color gain, and tint are not available for RGB signal input.) They are adjusted to the optimum value before shipping but, they can be readjusted by the built-in variable resistor(BRT, CNT, CLR, TNT) or external circuit shown in Appendix D.

3) In case of RGB input, apply composite video signal(V_{BS}) or composite sync signal (c-sync) with negative polarity to the sync separator.

4) Input signal 2

(1) Responsive to 0~0.7V_{P-P} analog RGB signal when V_{SW} is fixed to "low".

(2) In case of superimposing on composite video signal as on screen display.

RGB signals shall be digital signal.(low : 0V_{P-P}, high : >2V_{P-P} available for 8 color display)

5) High : RGB Mode, Low : Video Mode (NTSC)

Product Specification

- 6) Select input signal(composite or standard analog RGB)
- (1) When V_{sw} is “high” or open, composite video signal(Pin No. 11) is selected.
 - (2) When V_{sw} is “low”, analog RGB signal sets (Pin No. 13, 15, 17) is selected.

Caution : The shielding case is connected to the GND terminal which cuts electrical signals short.

The backlight interface connector is a model BHR-03VS-1, manufactured by JST. The mating connector part number SM02(8.0) B-BHS-1-TB or equivalent. The pin configuration for the connector is shown in the table below

Table5. BACK LIGHT CONNECTOR PIN CONFIGURATION

Pin	Symbol	Description	Note
1	HV	Lamp power input	
2	NC	No connection	
3	LV	Ground	

6. Signal Timing Specifications

Parameter	Symbol	Value			Units	Notes
		Min.	Typ.	Max.		
\overline{HSY}	Frequency	f_{HSYNC}	-	15.7	-	kHz
	High duration	t_{HSYNCH}	-	58.9	-	β_i
	Low duration	t_{HSYNCL}	-	4.6	-	β_i
\overline{VSY}	Frequency	f_{VSYNC}	-	60	-	Hz
	High duration	t_{VSYNCH}	-	16.48	-	msec
	Low duration	t_{VSYNCL}	-	192	-	β_i
Horizontal sync.	Input pulse width	T_{hs1}	4.2	4.7	5.7	β_i
	Output pulse width	T_{hs2}	4.5	5.0	5.5	β_i
Horizontal sync. phase difference		T_{pd}	-2.0	-	2.0	β_i
Vertical sync. output pulse		T_{vs}		192		β_i
Vertical sync. phase difference	odd field	T_{pv}	31	37	43	β_i
	even field		24	30	36	β_i

Product Specification

7. Signal Timing Waveforms

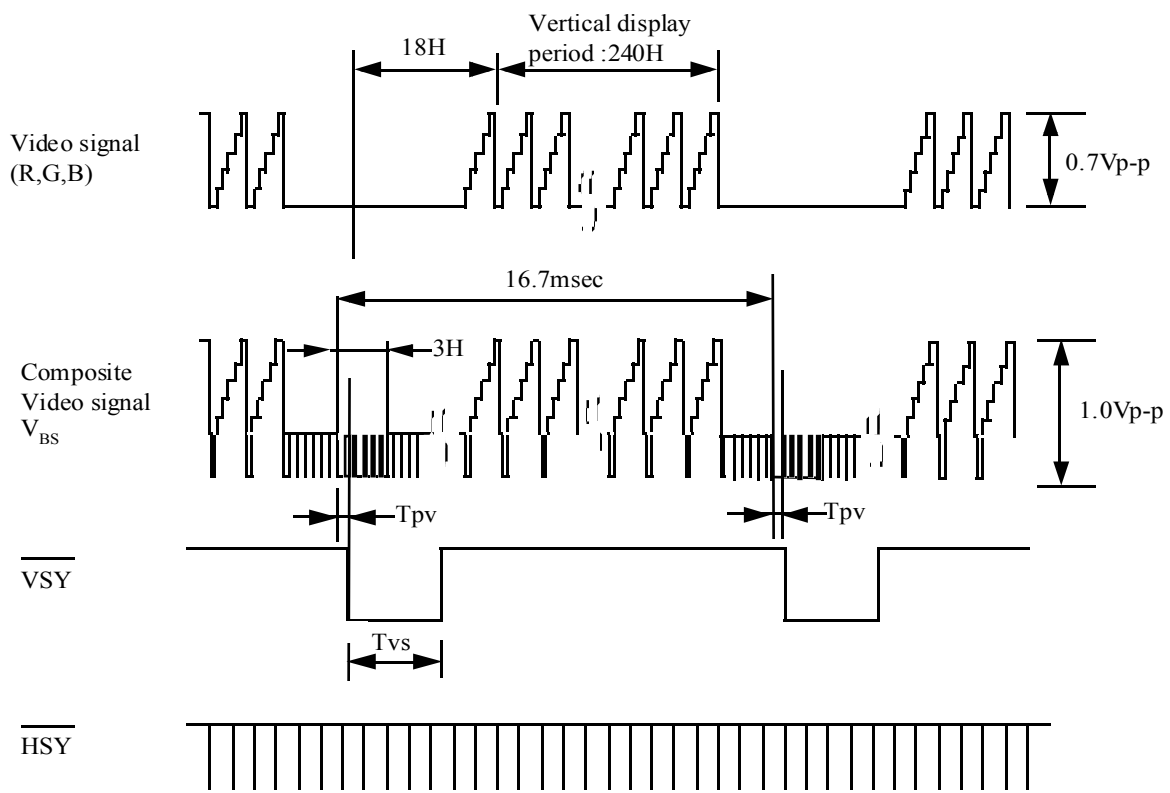
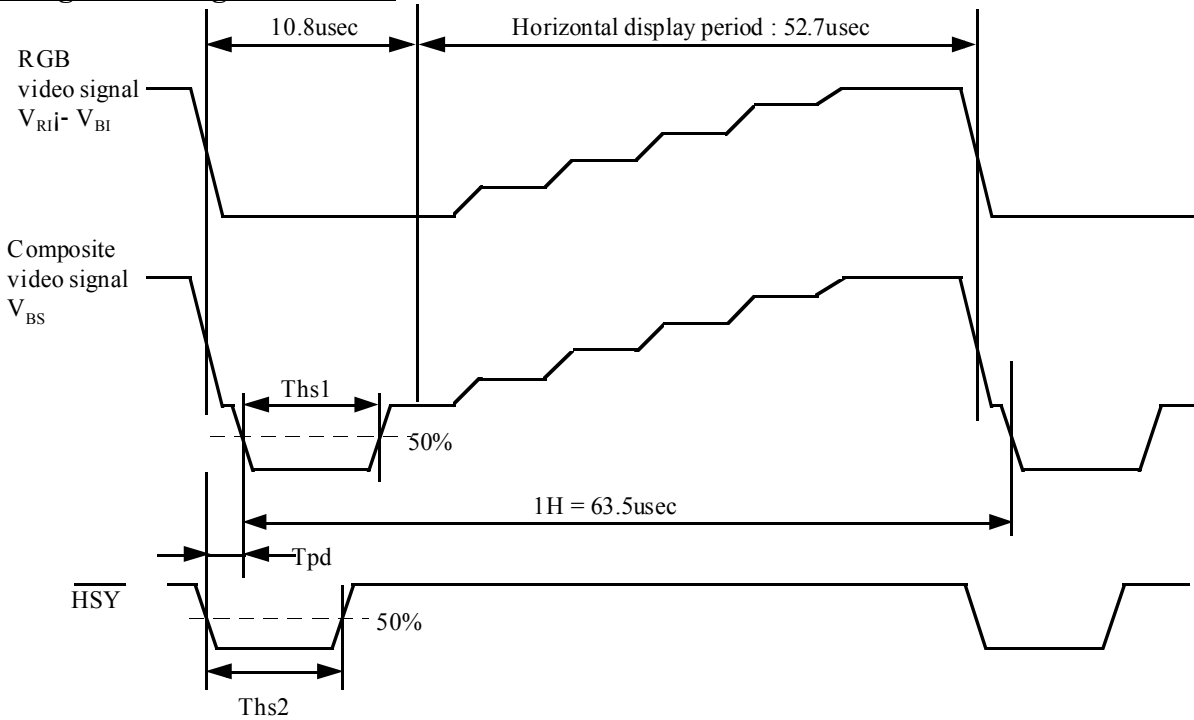

Product Specification
8. Mechanical Characteristics

The chart below provides general mechanical characteristics for the LC064N1. The C/F's black matrix has CrO_x coating that minimize reflection. The below diagram is a detailed mechanical drawing of the LCD. Note that dimension are given for reference purposes only.

Outside dimensions:	Width	168.0 mm
	Height	123.0 mm
	Thickness	15.5 mm
Active Display area:	Width	130.56 mm
	Height	97.92 mm
	Diagonal	162.6 mm
Viewing area dimension	Width	130.56 mm
	Height	95.472 mm
	Diagonal	161.743 mm
Weight (Typical)		310gram

Product Specification

9. Reliability test

9.1 Drop test

Conduct the following drop test with the chassis unit and should operate as normal usage without any damage after this test.

Acceleration	:	100G 6ms each °X, °Y, °Z
Secure	:	Screw
Times	:	3

9.2 Vibration test

Conduct the following vibration test with the chassis unit and should operate as normal usage without any damage after this test.

Frequency(Hz)	:	10 to 55
Amplitude	:	1.5m 0.5 Oct/min each X.Y.Z
1 cycle period	:	3 minutes(back and force)
Secure	:	Screw
Time	:	Up/Down: Forward/Back: 2 hours Right/Left:

9.3 Pressure reduction test

Set up the unit in the pressure reduction chamber and reduce the air pressure gradually from the normal pressure to 510hPa(300mmHg) which is equivalent to 5,000m height. There should have no damage to turn on the unit with 10% increased power for 30 minutes and repeat power on and off for 3 times quickly

9.4 High temperature storage(without power)

Keep the unit in 60°.temperature and 50% humidity chamber for 240 hours without power. Take out the unit to make it normal temperature and make sure that the unit has no safety hazard and operate as normal usage without any damage

9.5 Low temperature storage(without power)

Keep the unit in -20°.temperature and 0% humidity chamber for 240 hours without power. Take out the unit to make it normal temperature and make sure that the unit has no safety hazard and operate as normal usage without any damage

9.6 Humidity test(with power)

Operate the unit in 40°temperature and 90% humidity chamber for 240 hours with power. Make sure that the unit has no safety hazard and operate as normal usage without any damage

9.7 High temperature test(with power)

Operate the unit in 50°temperature and 50% humidity chamber for 240 hours with power. Make sure that the unit has no safety hazard and operate as normal usage without any damage

9.8 Low temperature test(with power)

Operate the unit in 0°temperature and 0% humidity chamber for 240 hours with power. Make sure that the unit has no safety hazard and operate as normal usage without any damage

Product Specification

9.9 Electrostatic discharge test

Discharge DC 8kV under non operating to chassis angle for 10 times of 1 second interval with 330 \cdot 150pF probe.

Make sure that the unit has operate as normal usage without any damage

9.10 Thermal shock test

Keep the unit in the following temperature chamber without power.

Take out the unit to make it normal temperature and make sure that the unit has no safety hazard and operate as normal usage without any damage.

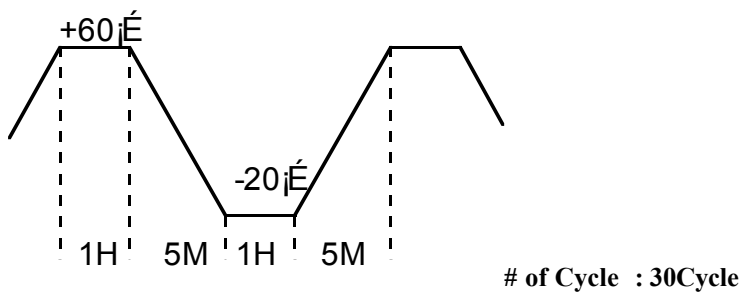

10. Handling precautions

- 10.1 Be sure to turn off the power when connecting or disconnecting circuit.
- 10.2 Note that polarizer are easily damaged, pay attention not to scratch or press these surface with any hard object.
- 10.3 When LCD surface become dirty, please wipe them off with soft material like absorbent cotton
- 10.4 Protect the module from the ESD. As it may damages electronic circuit (C-MOS).
Make certain that treatment person's body are grounded thru wrist bend.
- 10.5 Do not disassemble the module and be careful not to have strong mechanical shock such as twist when install to the cabinet. It may cause damage permanently.
- 10.6 Do not leave the module in high temperature, especially in high humidity for a long time.
- 10.7 Store the module not to expose to the sunlight directly.
- 10.8 Avoid condensation of water. It may cause misoperation.

Product Specification

(Appendix A)

A.1 BRIGHTNESS UNIFORMITY

<Measuring point>

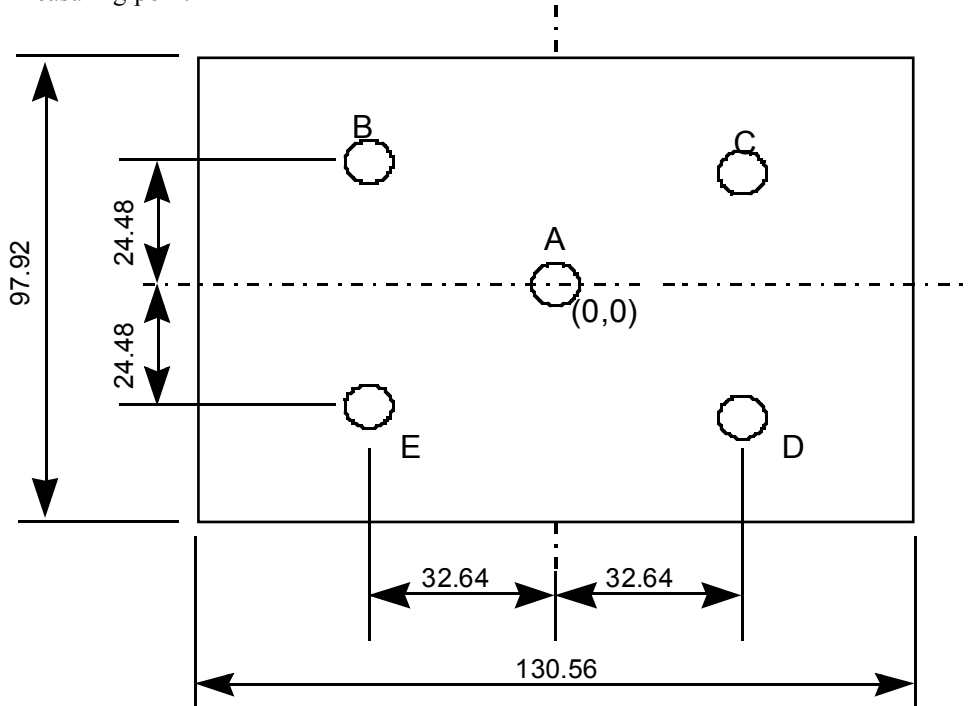

unit : mm

$$\text{Brightness Uniformity} = \frac{\text{Max}}{\text{Min}} = 1.42$$

A.2 RESPONSE TIME

The response time is defined according to the below diagram and is measured by time needed to switch the input signal for “black” and “white”.

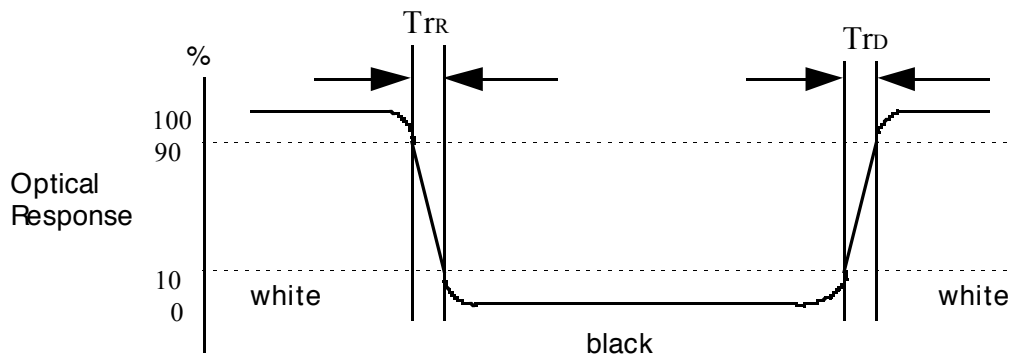

Product Specification

(Appendix A)

A.3 VIEWING ANGLE

Viewing angle is defined according to the below diagram.

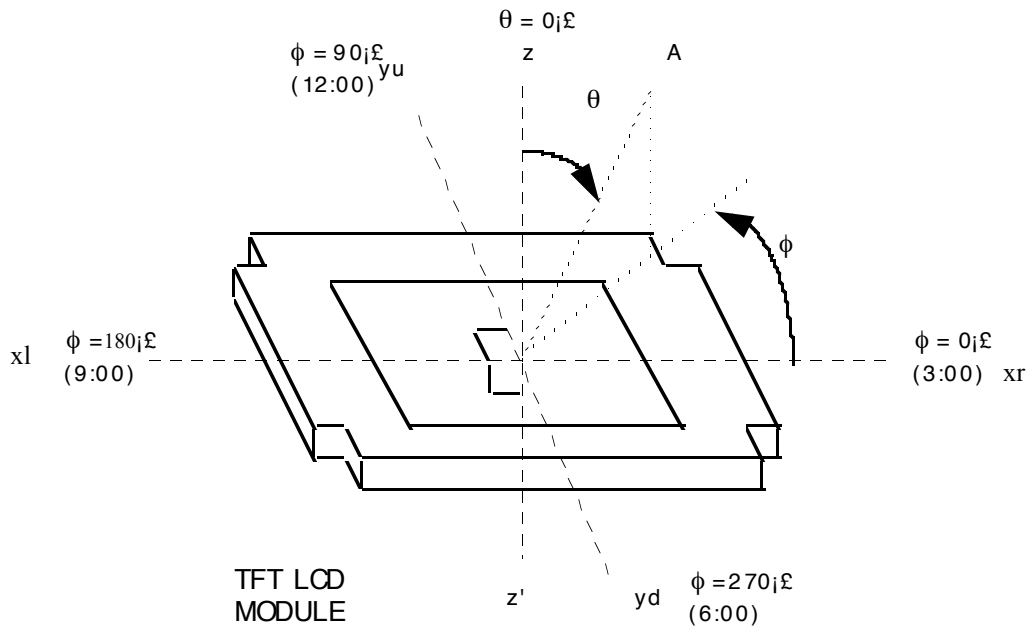

Product Specification

12. Drawing

