

ISSUED DATE : 2006-03-23

www.millotech.com

SAMSUNG TFT-LCD PRODUCT INFORMATION

MODEL : LTA150XH - L06

Note : This is Product Information is subject to change after 3 months of issuing date.

Product planning Group 2

Samsung Electronics Co . , LTD.



General Description ----- (3)

1. Absolute Maximum Ratings ----- (4)

2. Optical Characteristics ----- (6)

3. Electrical Characteristics ----- (11)

 3.1 TFT LCD Module

 3.2 Back Light Unit

4. Block Diagram ----- (16)

 4.1 TFT LCD Module

 4.2 Back Light Unit

5. Input Terminal Pin Assignment ----- (17)

 5.1 Input Signal & Power

 5.2 LVDS Interface

 5.3 Back Light Unit

 5.4 Input Signals, Basic Display Colors and Gray Scale of Each Color

 5.5 Timing Diagrams of LVDS

 5.6 Pixel Format

6. Interface Timing ----- (24)

 6.1 Timing Parameters (DE only mode)

 6.2 Timing Diagrams of interface Signal (DE only mode)

 6.3 Power ON/OFF Sequence

 6.4 VDD Power Dip Condition

7. General Precaution ----- (31)

 7.1 Handling

 7.2 Storage

 7.3 Operation

 7.4 Others

General Description

Description

LTA150XH-L06 is a color active matrix liquid crystal display (LCD) that uses amorphous silicon TFT (Thin Film Transistor) as switching components. This model is composed of a TFT LCD panel, a driver circuit and a back light unit. The resolution of a 15" is 1024 x 768 and this model can display up to 16.2 millions colors.

Features

- High contrast ratio, high aperture structure
- TN (Twisted Nematic) mode
- Wide Viewing Angle
- High speed response
- XGA (1024 x 768 pixels) resolution
- Low power consumption
- DE (Data Enable) only mode
- LVDS (Low Voltage Differential Signaling) interface (1pixel/clock)
- Compact Size Design

Applications

- TV & Desktop monitors
 - Display terminals for AV application products
 - Monitors for industrial machine
- * If the module is used to other applications besides the above, please contact SEC in advance.

General Information

Items	Specification	Unit	Note
Active Display Area	304.1(H) x 228.1(V)	mm	
Surface Treatment	Haze 25, Anti-glare & Hard-Coatig(3h)		
Display Colors	16.2M	colors	
Number of Pixels	1,024 x 738	pixel	
Pixel Arrangement	RGB vertical stripe		
Display Mode	Normally White		
Luminance of White	400(Typ.)	cd/m ²	

Mechanical Information

Item		Min.	Typ.	Max.	Unit	Note
Module size	Horizontal (H)	-	331.6	-	mm	
	Vertical (V)	-	254.8	-	mm	
	Depth (D)	-	12.5	-	mm	
Weight		-	-	1350	g	LCD module only

Note (1) Mechanical tolerance is $\pm 0.5\text{mm}$ unless there is a special comment.

1. Absolute Maximum Ratings

If the condition exceeds maximum ratings, it can cause malfunction or unrecoverable damage to the device.

Item	Symbol	Min.	Max.	Unit	Note
Power Supply Voltage	V_{DD}	GND-0.3	3.6	V	
Data Signal	V_{sig}	-	5	V	
Storage temperature	T_{STG}	-25	60		(1)
Glass surface temperature (Operation)	T_{OPR}	0	50		
Shock (non - operating)	S_{nop}	-	50	G	(2)
Vibration (non - operating)	V_{nop}	-	1.5	G	(3)

Note (1) $T_a = 25 \pm 2 \text{ }^\circ\text{C}$

- (1) Temperature and relative humidity range are shown in the figure below.
 - a. 90 % RH Max. (Ta 39 °C)
 - b. Maximum wet-bulb temperature at 39 °C or less. (Ta 39 °C)
 - c. No condensation
- (2) 11ms, sine wave, one time for ±X, ±Y, ±Z axis
- (3) 10-300 Hz, Sweep rate 10min, 30min for X,Y,Z axis

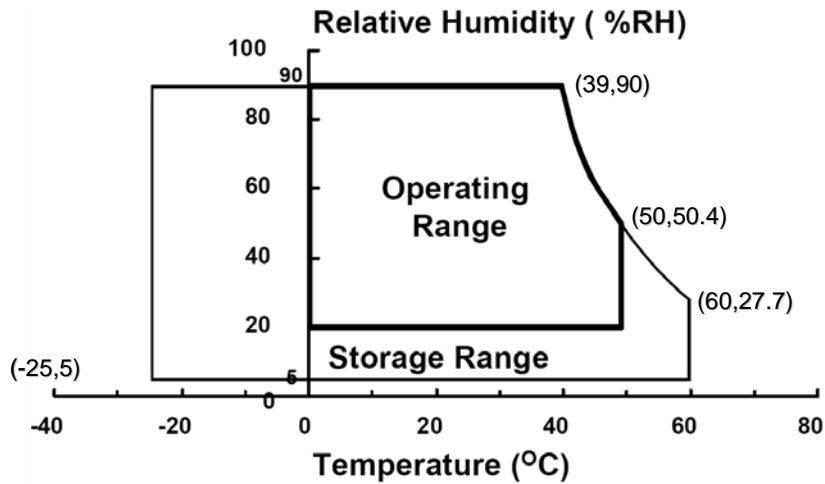

Fig. Temperature and Relative humidity range

2. Optical Characteristics

The optical characteristics should be measured in a dark room or equivalent.

Measuring equipment : TOPCON BM-7,SPECTRORADIOMETER SR-3

(Ta = 25 ± 2°C, VDD=3.3V, fv= 60Hz, fDCLK=65MHz, IL = 6mArms

Item		Symbol	Condition	Min.	Typ.	Max.	Unit	Note
Contrast Ratio (Center of screen)		C/R		300	400	-		(3) SR-3
Response Time	Rising	Tr	Normal L,R=0 U,D=0 Viewing Angle	-	5	10	msec	(5) BM-7
	Falling	Tf		-	20	25		
Luminance of White (Center of screen)		Y _L		350	400	-	cd/m2	(6) SR-3
Color Chromaticity (CIE 1931)	Red	Rx		-	0.624	-		(7),(8)
		Ry		-	0.356	-		
	Green	Gx		-	0.280	-		
		Gy		-	0.585	-		
	Blue	Bx		-	0.144	-		
		By		-	0.076	-		
	White	Wx		-	0.280	-		
		Wy	-	0.290	-			
Viewing Angle	Hor.	L	CR 10	60	70	-	Degrees	(8) SR-3
		R		60	70	-		
	Ver.	U		50	60	-		
		D		50	65	-		
Brightness Uniformity (9 Points)		B _{uni}		-	-	25	%	(4) SR-3

Note (1) Test Equipment Setup

The measurement should be executed in a stable, windless and dark room between 30min after lighting the back light at the given temperature for stabilization of the back light. This should be measured in the center of screen.

Single lamp current : 6mA

Environment condition : $T_a = 25 \pm 2 \text{ }^\circ\text{C}$

Photo detector	Field
SR-3	1 °
BM-7	2 °

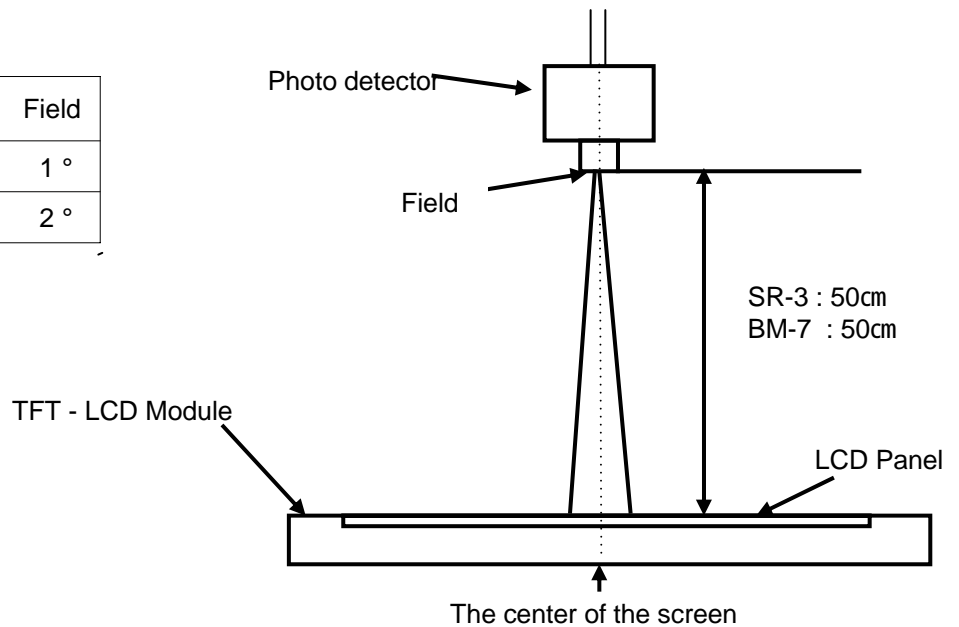

Note (2) Definition of test point

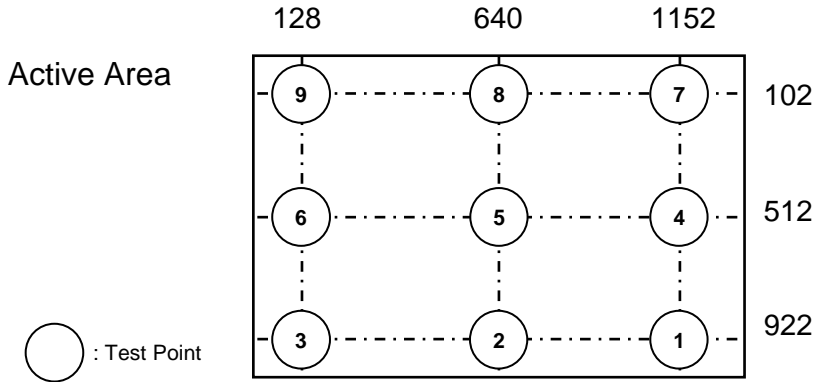

Note (3) Definition of Contrast Ratio (C/R)

: Ratio of gray max (Gmax) & gray min (Gmin) at the center point of the panel

$$CR = \frac{G \max}{G \min}$$

Gmax : Luminance with all pixels white

Gmin : Luminance with all pixels black

Note (4) Definition of 9 points brightness uniformity

$$Buni = 100 \times \frac{(B \max - B \min)}{B \max}$$

Bmax : Maximum brightness

Bmin : Minimum brightness

Note (5) Definition of Response time : Sum of Tr, Tf

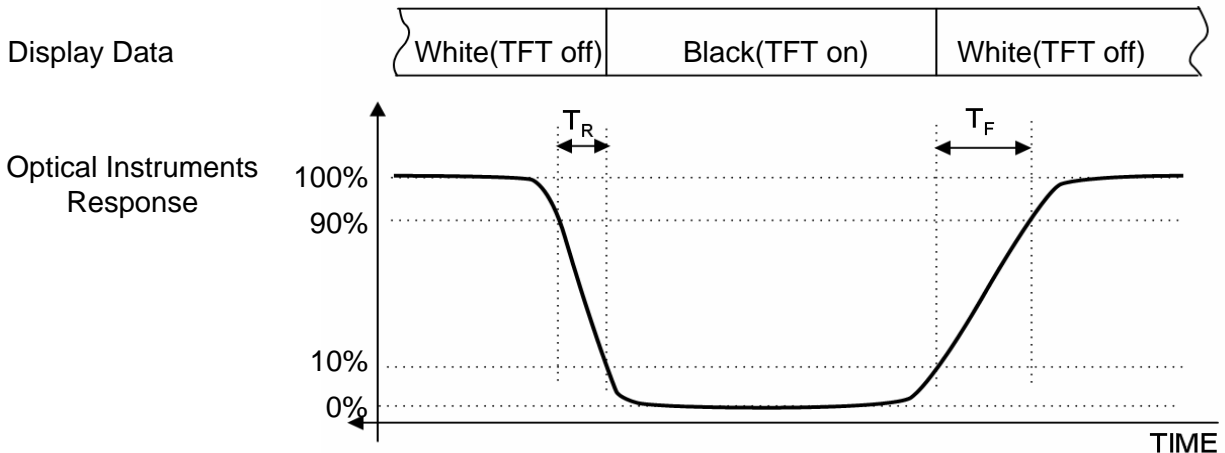

Note (6) Definition of Luminance of White : Luminance of white at center point

Note (7) Definition of Color Chromaticity (CIE 1931, CIE1976)
 Color coordinate of Red, Green, Blue & White at center point

Note (8) Definition of Viewing Angle
 : Viewing angle range (CR 10)

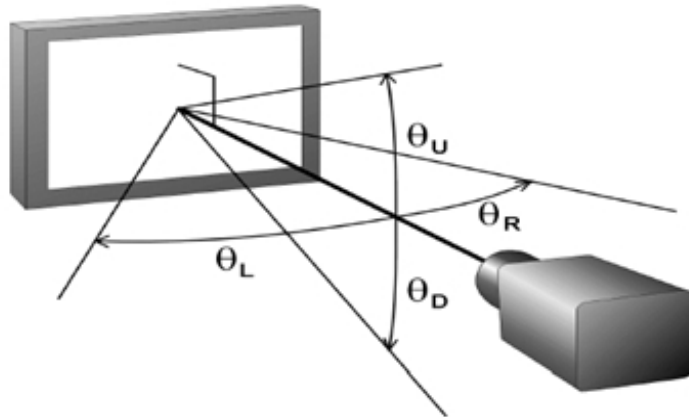

3. Electrical Characteristics

3.1 TFT LCD Module

The connector for display data & timing signal should be connected (GND=0V)

Ta = 25°C

Item		Symbol	Min.	Typ.	Max.	Unit	Note
Voltage of Power Supply		V_{DD}	3.0	3.3	3.6	V	(1)
LVDS Input Characteristics	Differential Input Voltage for LVDS Receiver Threshold	High	-	-	+100	mV	(2)
		Low	-100	-	-	mV	
	LVDS skew	t_{SKEW}	-300		300		(3)
	Differential input voltage	$ V_{ID} $	200		600	mV	(4)
	Input voltage range (single-ended)	V_{IN}	0		2.4	V	(4)
	Common mode voltage	V_{CM}	0+ $ V_{ID} /2$	1.2	2.4- $ V_{ID} /2$	V	(4)
Current of Power Supply	White	I_{DD}	-	400	460-	mA	(5),(6)
	Mosaic		-	420	480	mA	
	Sub-pixel checker		-	470	550	mA	
Vsync Frequency		f_V	-	60	75	Hz	
Hsync Frequency		f_H	-	48.3	60.0	kHz	
Main Frequency		f_{DCLK}	47	65	80	MHz	
Rush Current		I_{RUSH}	-	-	1.5	A	(7)

Note (1) The ripple voltage should be controlled under 10% of V_{DD} .

- (2) Differential receiver voltage definitions and propagation delay and transition time test circuit
- a. All input pulses have frequency = 10MHz, t_R or $t_F=1ns$
 - b. C_L includes all probe and fixture capacitance

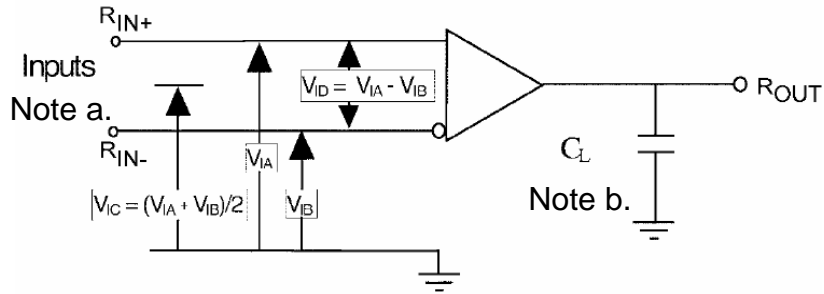

(3) LVDS Receiver DC parameters are measured under static and steady conditions which may not be reflective of its performance in the end application.

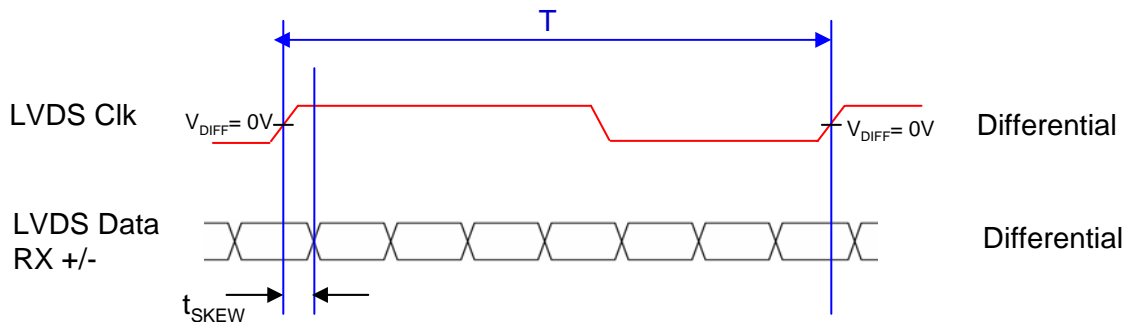

where t_{skew} : skew between LVDS clock & LVDS data,

T : 1 period time of LVDS clock

cf) (-/+) of 380psec means LVDS data goes before or after LVDS clock.

(4) Definition of V_{ID} and V_{CM} using single-end signals

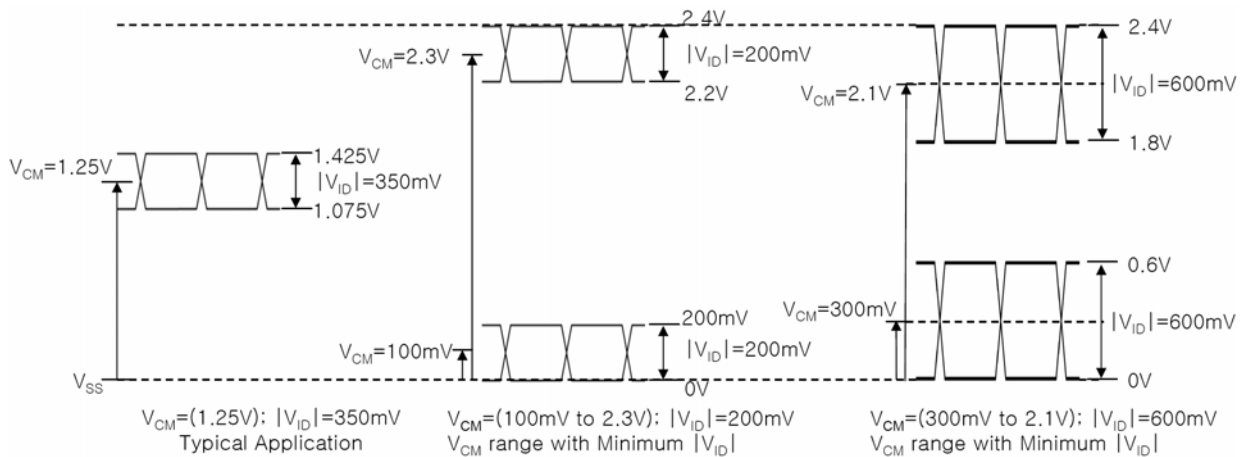

(5) $f_V=60\text{Hz}$, $f_{\text{DCLK}} = 65\text{MHz}$, $V_{\text{DD}} = 3.3\text{V}$, DC Current.

(6) Power dissipation check pattern (LCD Module only)

a) White Pattern



b) Mosaic Pattern

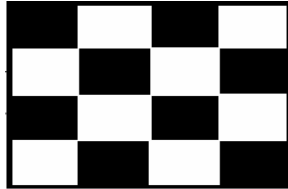

c) Dot Pattern

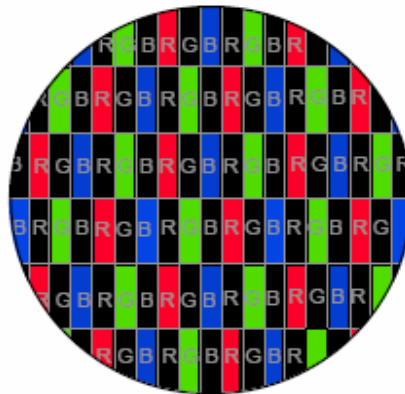
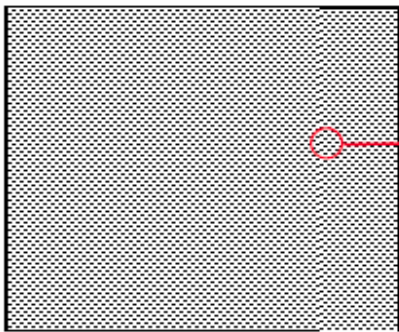

(7) Measurement Condition

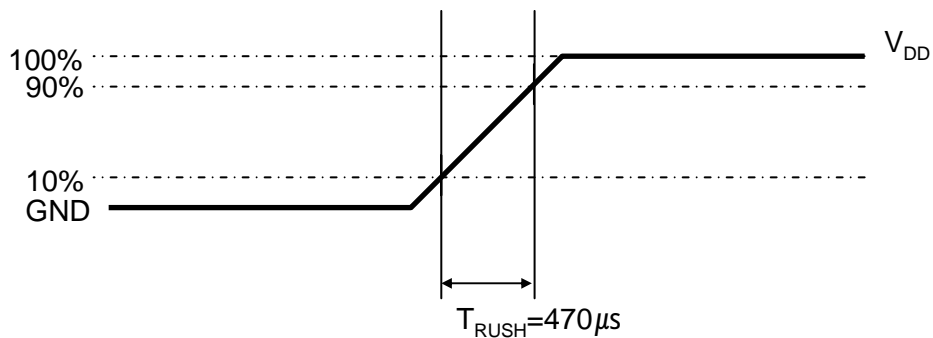

Rush Current I_{RUSH} can be measured when T_{RUSH} is $470\mu\text{s}$.

3.2 Back Light Unit

The back light unit is a direct type with 4 CCFTs (Cold Cathode Fluorescent Tube)
 The characteristics of two dual lamps are shown in the following tables.

Ta=25 ± 2°C

Item	Symbol	Min.	Typ.	Max.	Unit	Note	
Lamp Current	I_L	(3.0)	6.0	(6.5)	mArms	(1)	
Lamp Voltage	V_L	-	(665)	-	Vrms		
Lamp Frequency	f_L	40	-	60	kHz	(3)	
Operating Life Time	Hr	25,000	35,000	-	Hour	(4)	
Inverter waveform	Asymmetry rate	Wasy	-	-	10	%	(5)
	Distortion rate	Wdis	1.2726	1.414	1.5554		
Startup Voltage	V_s	-	-	0 : (1,570)	Vrms	(6)	
				25 : (1,120)			

Note (1) Specified values are for a single lamp.

Lamp current is measured with current meter for high frequency as shown below.
 Refer to the following block diagram of the back light unit for more information.

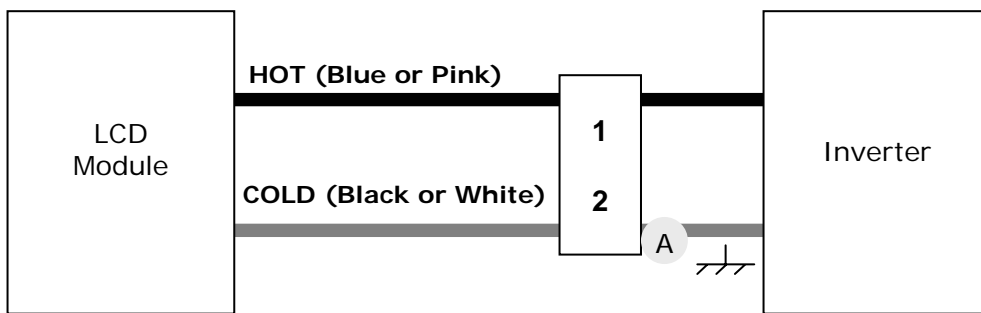

Fig. Measurement point of Lamp Current

(2) Define of Lamp current uniformity : I_{UNI}

$$I_{UNI} = \frac{|I_{Max} - I_{Min}|}{I_{Max}} \times 100$$

I_{max} : Maximum lamp current

I_{min} : Minimum lamp current

Lamp current uniformity I_{UNI} should be less than 25%

(3) Lamp frequency which may produce interference with horizontal synchronous frequency may cause line flow on the display. Therefore lamp frequency should be detached from the horizontal synchronous frequency and its harmonics as far as possible in order to avoid interference.

(4) Life time (Hr) is defined as the time when brightness of a lamp unit itself becomes 50% or less than its original value at the condition of $T_a = 25 \pm 2^\circ\text{C}$ and $I_L = 7.5\text{mA}_{rms}$

(5) Designing a system inverter intended to have better display performance, power efficiency and lamp reliability.

They would help increase the lamp lifetime and reduce leakage current.

- a. The measurement should be done at typical lamp current.
- b. The asymmetry rate of the inverter waveform should be less than 10%.
- c. The distortion rate of the waveform should be ≤ 2 with $\pm 10\%$ tolerance.
 - Inverter output waveform had better be more similar to ideal sine wave.

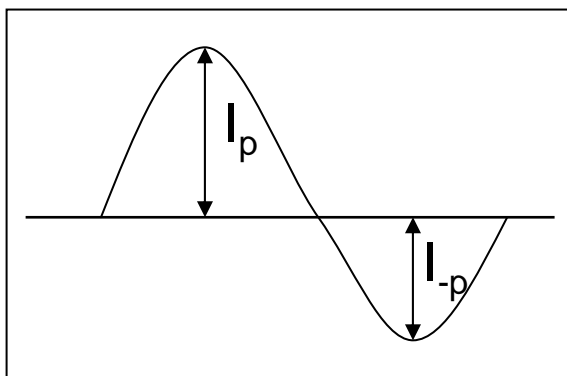

Fig. Wave form of the inverter

▪ Asymmetry rate

$$\frac{|I_p - I_{-p}|}{I_{rms}} \times 100$$

▪ Distortion rate

$$\left| \frac{I_p}{I_{rms}} \right| \text{ or } \left| \frac{I_{-p}}{I_{rms}} \right|$$

(6) If an inverter has shutdown function, it should keep its output for over 1 second even if the lamp connector is open. Otherwise the lamps may not be turned on.

4. BLOCK DIAGRAM

4.1 TFT LCD Module

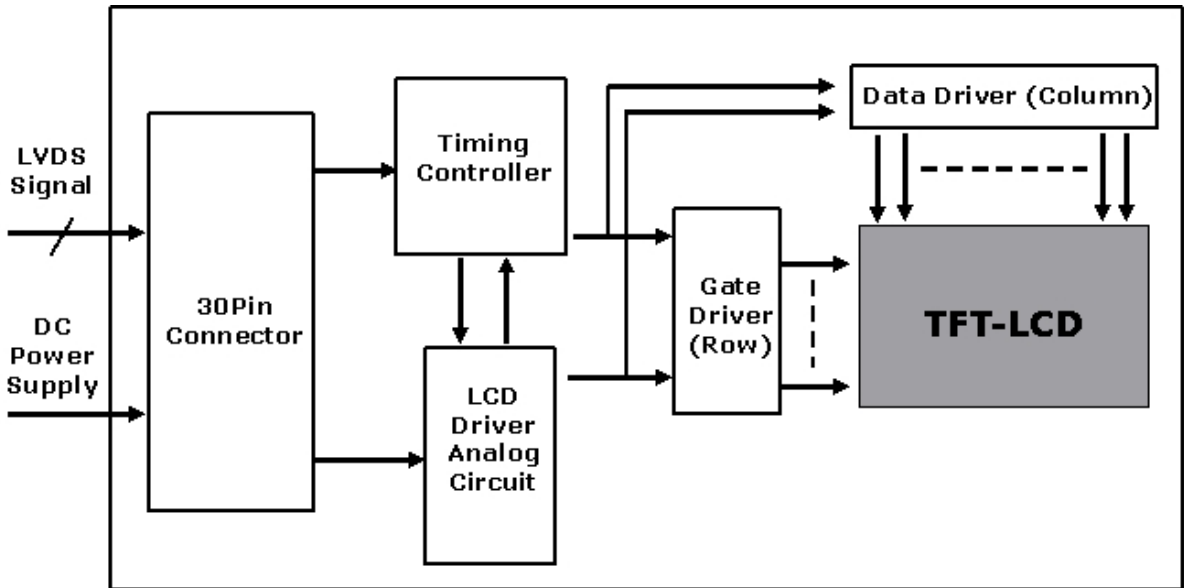

4.2 Back Light Unit

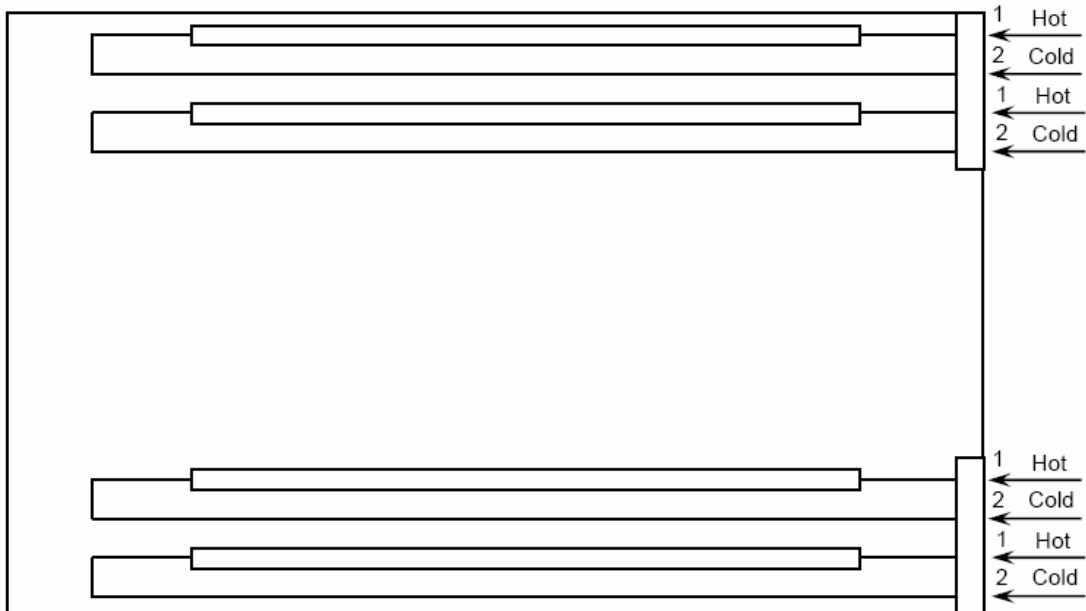

5. Input Terminal Pin Assignment

5.1 Input Signal & Power (Connector : Hirose DF14H-20P-1.25H)

Matching Socket : Hirose DF14-20S-1.25C

PIN NO	SYMBOL	FUNCTION	POLARITY	Output Pin# (LVDS Tx)	NOTE
1	VDD	Power Supply +3.3 V			
2	VDD	Power Supply +3.3 V			
3	GND	Power Ground			
4	GND	Power Ground			
5	RXIN0 -	LVDS Receiver Signal(-)	Negative	PIN#48	
6	RXIN0 +	LVDS Receiver Signal(+)	Positive	PIN#47	
7	GND	Ground	-		
8	RXIN1 -	LVDS Receiver Signal(-)	Negative	PIN#46	
9	RXIN1 +	LVDS Receiver Signal(+)	Positive	PIN#45	
10	GND	Ground	-		
11	RXIN2 -	LVDS Receiver Signal(-)	Negative	PIN#42	
12	RXIN2 +	LVDS Receiver Signal(+)	Positive	PIN#41	
13	GND	Ground	-		
14	RXCLK IN -	LVDS Receiver Clock Signal(-)	Negative	PIN#40	
15	RXCLK IN+	LVDS Receiver Clock Signal(+)	Positive	PIN#39	
16	GND	Ground	-		
17	RXIN3 -	LVDS Receiver Signal(-)	Negative	PIN#38	
18	RXIN3 +	LVDS Receiver Signal(+)	Positive	PIN#37	
19	GND	Ground	-		
20	NC	SEC's Internal use only	-		(1)

Note (1) If customer's system already uses the 20pin as GND, It should not exceed -200mV.

5.2 LVDS Interface

LVDS INTERFACE

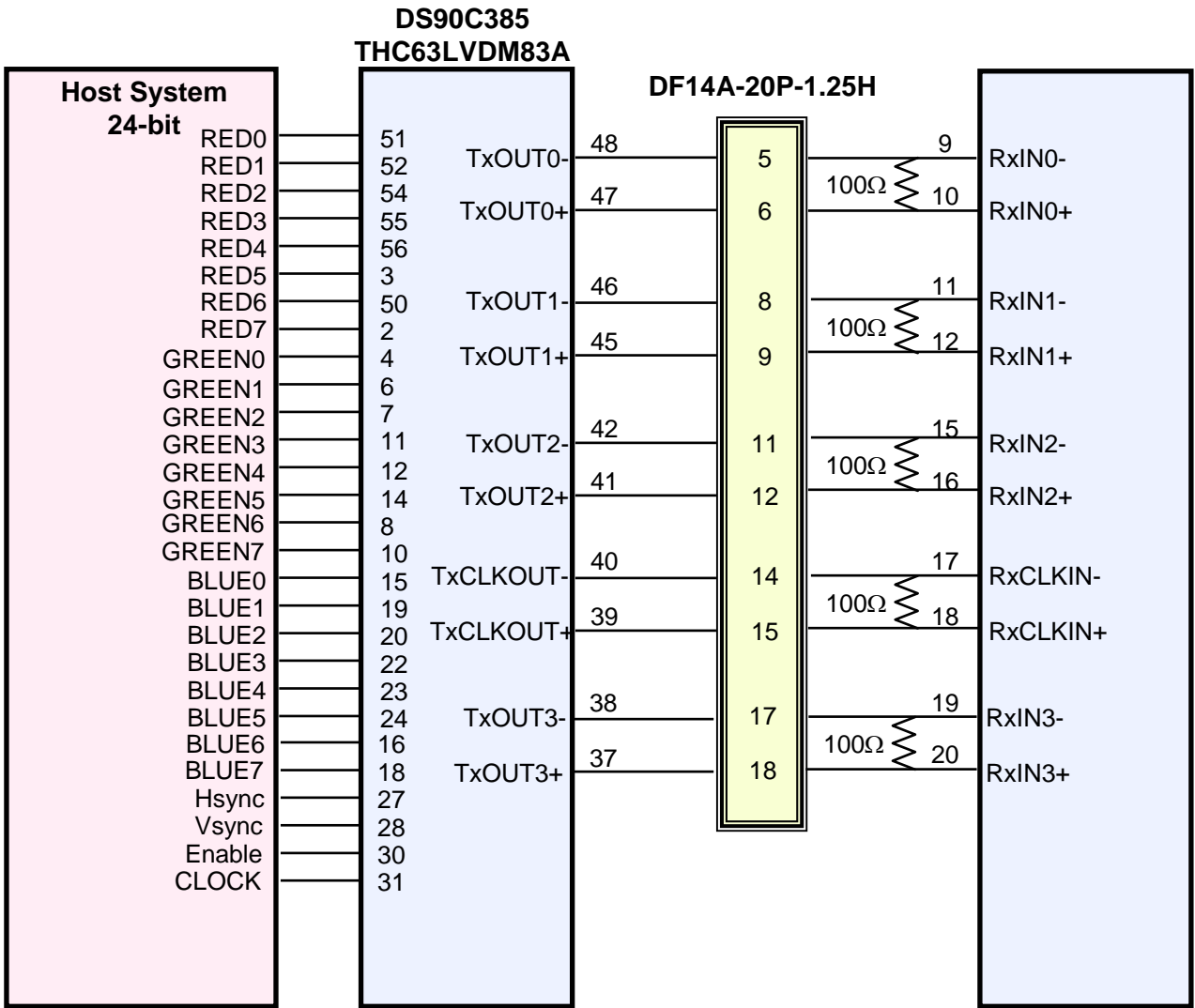

Note : The LCD Module uses a 100ohm resistor between positive and negative lines of each receiver input.

5.3 BACK-LIGHT UNIT

Connector : JST BHSR - 02VS -1
Mating Connector : SM02B-BHSS-1(JST)

Pin NO.	Symbol	Color	Function
1	HOT	Pink or Blue	High Voltage
2	COLD	White or Black	Ground

5.4 Input Signal, Basic Display Colors and Gray Scale of Each Colors

Color	Display	Data Signal																												Gray Scale Level
		Red							Green							Blue														
		R0	R1	R2	R3	R4	R5	R6	R7	G0	G1	G2	G3	G4	G5	G6	G7	B0	B1	B2	B3	B4	B5	B6	B7					
Basic Color	Black	0	0	0	0	0	0	0	0	0	0	0	0	0	0	0	0	0	0	0	0	0	0	0	0	0	0	0	-	
	Blue	0	0	0	0	0	0	0	0	0	0	0	0	0	0	0	0	1	1	1	1	1	1	1	1	1	1	-		
	Green	0	0	0	0	0	0	0	0	1	1	1	1	1	1	1	1	0	0	0	0	0	0	0	0	0	0	-		
	Cyan	0	0	0	0	0	0	0	0	1	1	1	1	1	1	1	1	1	1	1	1	1	1	1	1	1	1	-		
	Red	1	1	1	1	1	1	1	1	0	0	0	0	0	0	0	0	0	0	0	0	0	0	0	0	0	0	-		
	Magenta	1	1	1	1	1	1	1	1	0	0	0	0	0	0	0	0	1	1	1	1	1	1	1	1	1	1	-		
	Yellow	1	1	1	1	1	1	1	1	1	1	1	1	1	1	1	1	0	0	0	0	0	0	0	0	0	0	-		
	White	1	1	1	1	1	1	1	1	1	1	1	1	1	1	1	1	1	1	1	1	1	1	1	1	1	1	-		
Gray Scale of Red	Black	0	0	0	0	0	0	0	0	0	0	0	0	0	0	0	0	0	0	0	0	0	0	0	0	0	R000			
	Dark	1	0	0	0	0	0	0	0	0	0	0	0	0	0	0	0	0	0	0	0	0	0	0	0	0	R001			
		0	1	0	0	0	0	0	0	0	0	0	0	0	0	0	0	0	0	0	0	0	0	0	0	0	R002			
	↑	R003 ~ R252			
					
	↓	1	0	1	1	1	1	1	1	0	0	0	0	0	0	0	0	0	0	0	0	0	0	0	0	0	R252			
		0	1	1	1	1	1	1	1	0	0	0	0	0	0	0	0	0	0	0	0	0	0	0	0	0	R252			
	Light	1	1	1	1	1	1	1	1	0	0	0	0	0	0	0	0	0	0	0	0	0	0	0	0	0	R252			
Red	1	1	1	1	1	1	1	1	0	0	0	0	0	0	0	0	0	0	0	0	0	0	0	0	0	R252				
Gray Scale of Green	Black	0	0	0	0	0	0	0	0	0	0	0	0	0	0	0	0	0	0	0	0	0	0	0	0	0	G000			
	Dark	0	0	0	0	0	0	0	0	1	0	0	0	0	0	0	0	0	0	0	0	0	0	0	0	0	G001			
		0	0	0	0	0	0	0	0	0	1	0	0	0	0	0	0	0	0	0	0	0	0	0	0	0	G002			
	↑	G003 ~ G252			
					
	↓	0	0	0	0	0	0	0	0	1	0	1	1	1	1	1	1	0	0	0	0	0	0	0	0	0	G252			
		0	0	0	0	0	0	0	0	0	1	1	1	1	1	1	1	0	0	0	0	0	0	0	0	0	G252			
	Light	0	0	0	0	0	0	0	0	1	1	1	1	1	1	1	0	0	0	0	0	0	0	0	0	0	G252			
Green	0	0	0	0	0	0	0	0	1	1	1	1	1	1	1	0	0	0	0	0	0	0	0	0	0	G252				
Gray Scale of Blue	Black	0	0	0	0	0	0	0	0	0	0	0	0	0	0	0	0	0	0	0	0	0	0	0	0	0	B000			
	Dark	0	0	0	0	0	0	0	0	0	0	0	0	0	0	0	0	1	0	0	0	0	0	0	0	0	B001			
		0	0	0	0	0	0	0	0	0	0	0	0	0	0	0	0	0	1	0	0	0	0	0	0	0	B002			
	↑	B003 ~ B252			
					
	↓	0	0	0	0	0	0	0	0	0	0	0	0	0	0	0	0	1	0	1	1	1	1	1	1	1	B252			
		0	0	0	0	0	0	0	0	0	0	0	0	0	0	0	0	0	1	1	1	1	1	1	1	1	B252			
	Light	0	0	0	0	0	0	0	0	0	0	0	0	0	0	0	0	1	1	1	1	1	1	1	1	1	B252			
Blue	0	0	0	0	0	0	0	0	0	0	0	0	0	0	0	0	1	1	1	1	1	1	1	1	1	B252				

Note) ✓ Definition of Gray :

Rn : Red Gray, Gn : Green Gray, Bn : Blue Gray (n = Gray level)

✓ Input Signal : 0 = Low level voltage, 1 = High level voltage

5.5 Timing Diagrams of LVDS

LVDS Transmitter : National Semiconductor DS90C385MTD

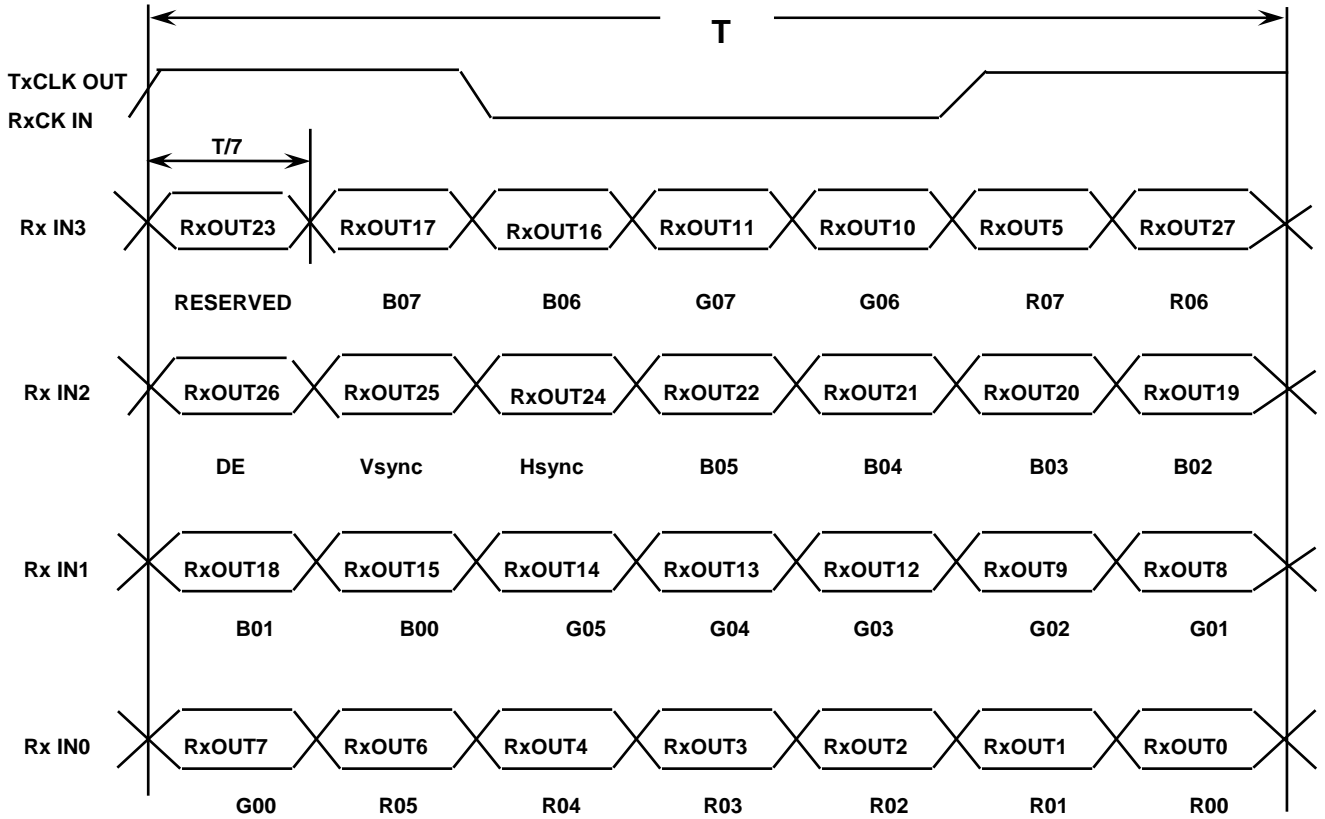

5.6 PIXEL FORMAT

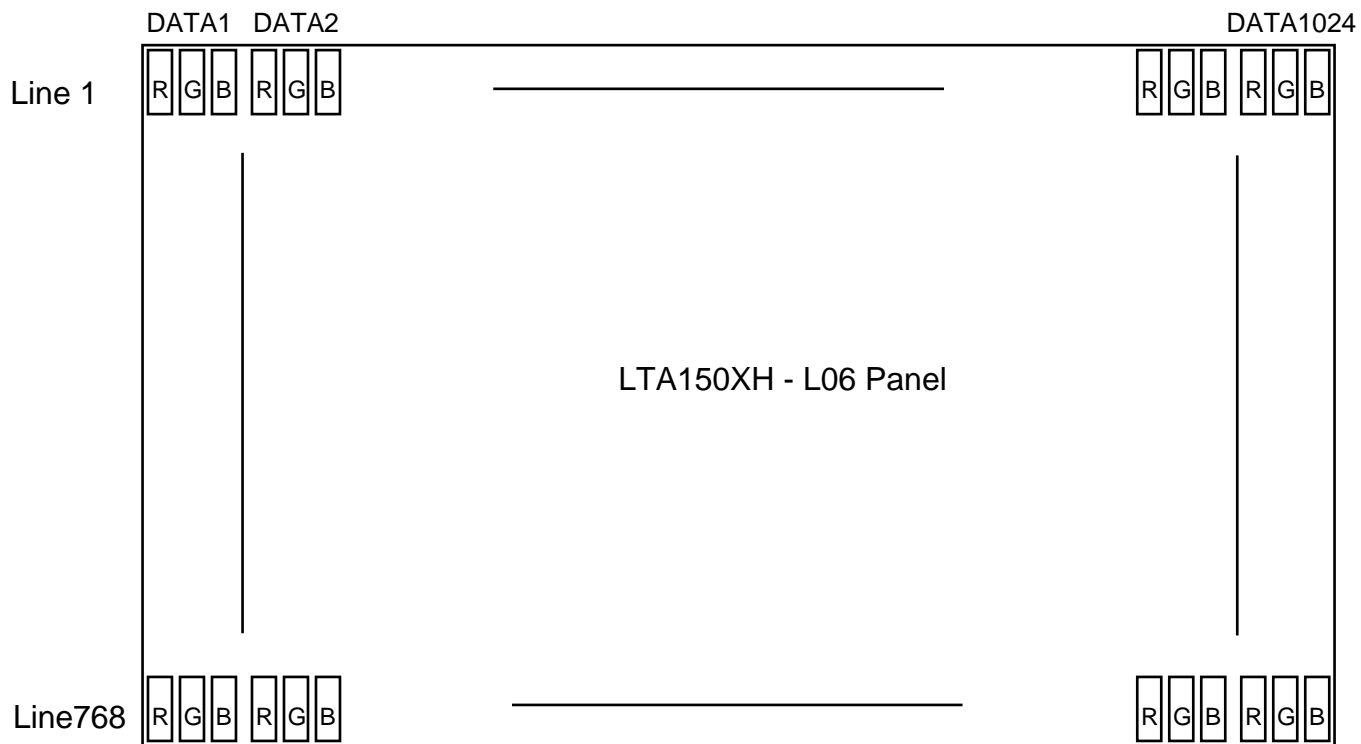

6. Interface Timing

6.1 Timing Parameters (DE only mode)

SIGNAL	ITEM	SYMBOL	MIN.	TYP.	MAX.	Unit	NOTE
Clock	Frequency	$1/T_C$	47	65	80	MHz	-
Hsync		F_H	-	48.3	60.0	KHz	-
Vsync		F_V	-	60	75	Hz	-
Vertical Display Term	Active Display Period	T_{VD}	768	768	768	lines	-
Horizontal Display Term	Active Display Period	T_{HD}	1024	1024	1024	clocks	-
	Horizontal Total	T_H	1100	1344	1800	clocks	-

Note (1) This product is DE only mode. The input of Hsync & Vsync signal does not have an effect on normal operation.

(2) Test Point : TTL control signal and CLK at LVDS Tx input terminal in system

(3) Internal Vcc = 3.3V

6.2 Timing diagrams of interface signal (DE only mode)

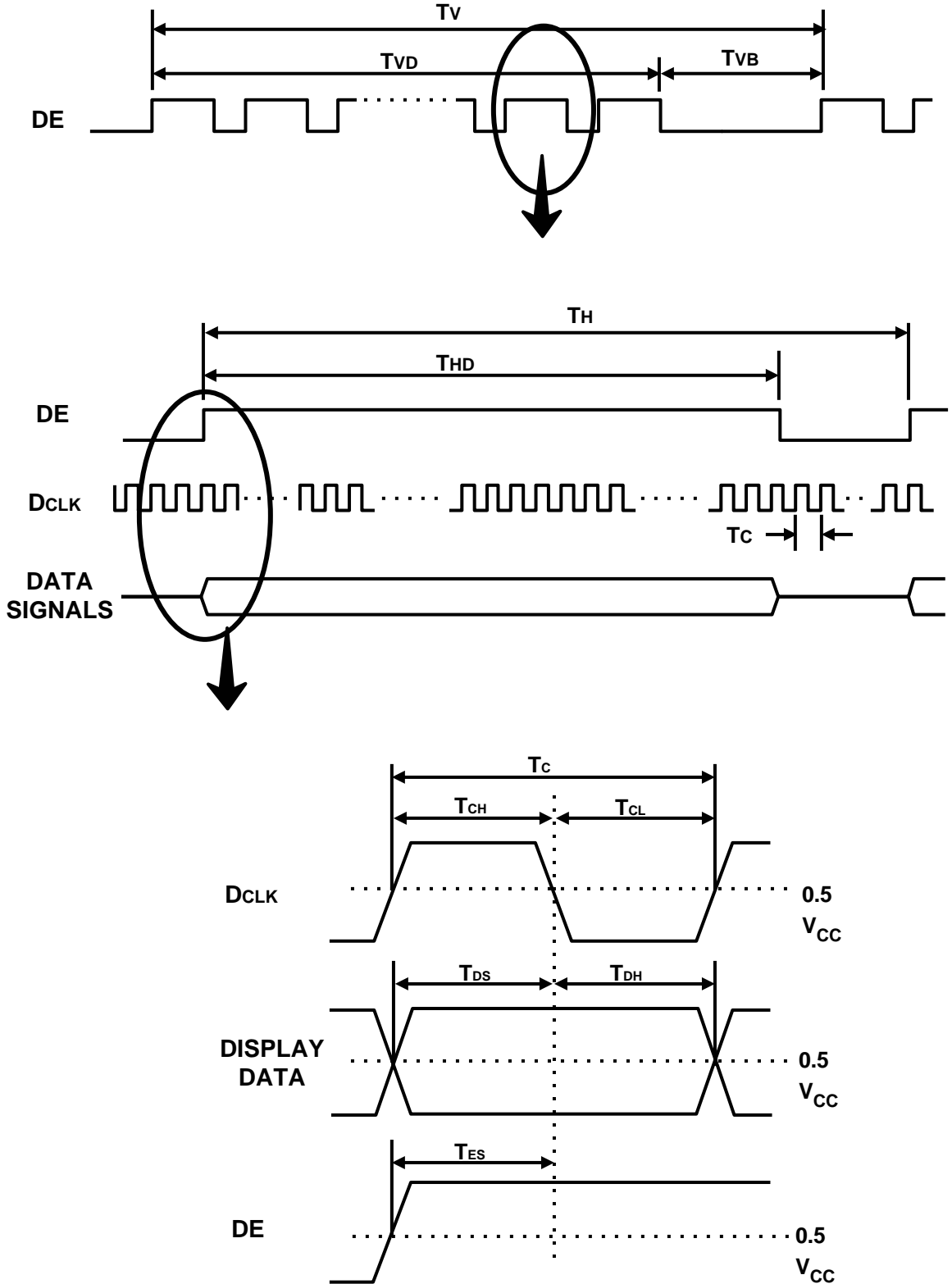

6.3 Power ON/OFF Sequence

To prevent a latch-up or DC operation of the LCD Module, the power on/off sequence should be as the diagram below.

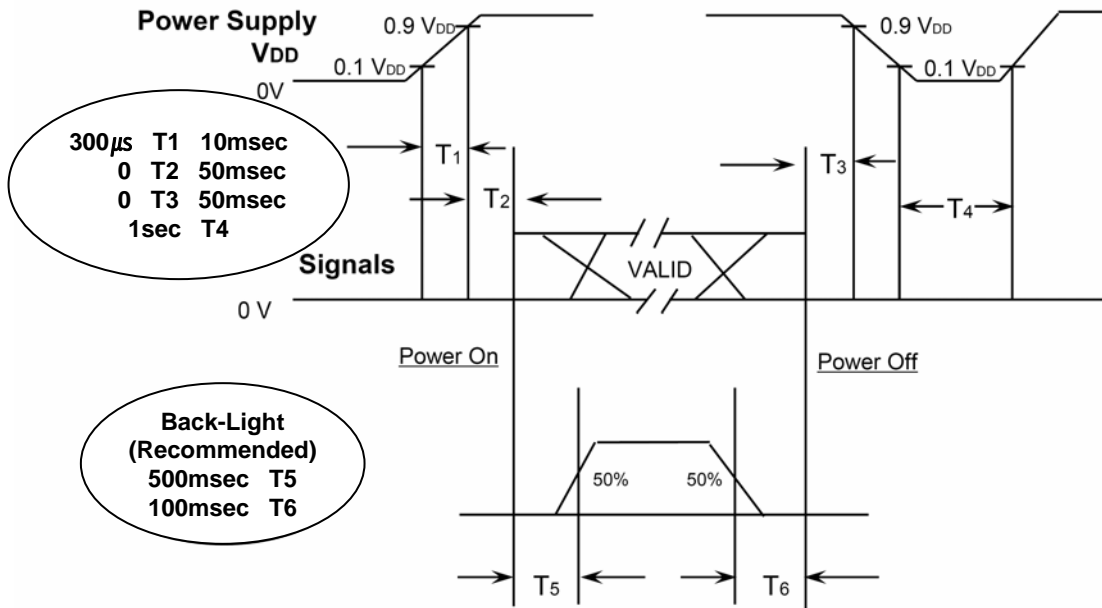

- T₁ : V_{DD} rising time from 10% to 90%
- T₂ : The time from V_{DD} to valid data at power ON.
- T₃ : The time from valid data off to V_{DD} off at power Off.
- T₄ : V_{DD} off time for Windows restart
- T₅ : The time from valid data to B/L enable at power ON.
- T₆ : The time from valid data off to B/L disable at power Off.

- The supply voltage of the external system for the Module input should be the same as the definition of V_{DD}.
- Apply the lamp voltage within the LCD operation range. When the back light turns on before the LCD operation or the LCD turns off before the back light turns off, the display may momentarily show abnormal screen.
- In case of V_{DD} = off level, please keep the level of input signals low or keep a high impedance.
- T₄ should be measured after the Module has been fully discharged between power off and on period.
- Interface signal should not be kept at high impedance when the power is on.

6.4 VDD Power Dip Condition

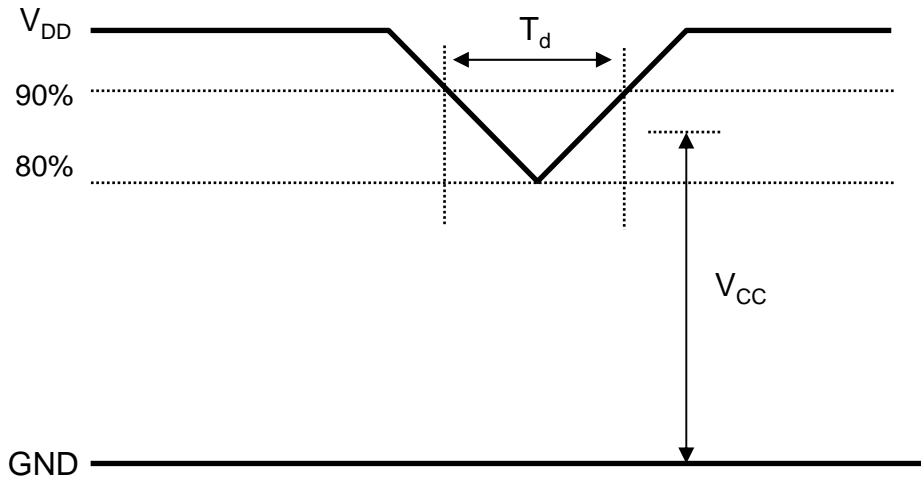

$\begin{aligned} & 3.0V \quad V_{DD} \quad 3.6V \\ \text{If } V_{DD}(\text{typ.}) \times 80\% & \quad V_{CC} \quad V_{DD}(\text{typ}) \times 90\% \\ \text{Then, } 0 < T_d & \quad 20\text{msec} \end{aligned}$

- Note (1) The above conditions are for the glitch of the input voltage.
 (2) For stable operation of an LCD Module power, please follow them.
 i.e., if $\text{typ } V_{DD} \times 80\% \quad V_{CC} \quad \text{typ } V_{DD} \times 90\%$, then T_d should be less than 20ms.

7. General Precautions

7.1 Handling

- (a) When the module is assembled, it should be attached to the system firmly using all mounting holes. Be careful not to twist and bend the module.
- (b) Because the inverter uses high voltages, it should be disconnected from power source before it is assembled or disassembled.
- (c) Refrain from strong mechanical shock and / or any force to the module. In addition to damage, it may cause improper operation or damage to the module and CCFT back light.
- (d) Note that polarizer films are very fragile and could be damaged easily. Do not press or scratch the surface harder than a HB pencil lead.
- (e) Wipe off water droplets or oil immediately. If you leave the droplets for a long time, staining or discoloration may occur.
- (f) If the surface of the polarizer is dirty, clean it using absorbent cotton or soft cloth.
- (g) Desirable cleaners are water, IPA (Isopropyl Alcohol) or Hexane. Do not use Ketone type materials (ex. Acetone), Ethyl alcohol, Toluene, Ethyl acid or Methyl chloride. It might cause permanent damage to the polarizer due to chemical reaction.
- (h) If the liquid crystal material leaks from the panel, it should be kept away from the eyes or mouth . In case of contact with hands, legs or clothes, it must be washed away with soap thoroughly.
- (i) Protect the Module from static, or the CMOS Gate Array IC would be damaged.
- (j) Use finger-stalls with soft gloves in order to keep display clean during the incoming inspection and assembly process.
- (k) Do not disassemble the Module.
- (l) Do not pull or fold the lamp wire.
- (m) Do not adjust the variable resistor located on the Module.
- (n) Protection film for polarizer on the Module should be slowly peeled off just before use so that the electrostatic charge can be minimized.
- (o) Pins of I/F connector should not be touched directly with bare hands.

7.2 Storage

- (a) Do not leave the Module in high temperature, and high humidity for a long time. It is highly recommended to store the Module with temperature from 0 to 35 and relative humidity of less than 70%.
- (b) Do not store the TFT-LCD Module in direct sunlight.
- (c) The Module should be stored in a dark place. It is prohibited to apply sunlight or fluorescent light in storing.

7.3 Operation

- (a) Do not connect or disconnect the Module in the "Power On" condition.
- (b) Power supply should always be turned on/off by the item 6.3 "Power on/off sequence"
- (c) Module has high frequency circuits. Sufficient suppression to the electromagnetic interference should be done by system manufacturers. Grounding and shielding methods may be important to minimize the interference.
- (d) The cable between the back light connector and its inverter power supply should be connected directly with a minimized length. A longer cable between the back light and the inverter may cause lower luminance of lamp(CCFT) and may require higher startup voltage(Vs).

7.4 Operation Condition Guide

- (a) The LCD product should be operated under normal conditions. Normal condition is defined as below;
 - Temperature : 20 ± 15
 - Humidity : $65 \pm 20\%$
 - Display pattern : continually changing pattern (Not stationary)
- (b) If the product will be used in extreme conditions such as high temperature, humidity, display patterns or operation time etc., It is strongly recommended to contact SEC for Application engineering advice. Otherwise, its reliability and function may not be guaranteed. Extreme conditions are commonly found at Airports, Transit Stations, Banks, Stock market, and Controlling systems.

7.5 Others

- (a) Ultra-violet ray filter is necessary for outdoor operation.
- (b) Avoid condensation of water. It may result in improper operation or disconnection of electrode.
- (c) Do not exceed the absolute maximum rating value. (supply voltage variation, input voltage variation, variation in part contents and environmental temperature, and so on)
Otherwise the Module may be damaged.
- (d) If the Module keeps displaying the same pattern for a long period of time, the image may be "sticked" to the screen.
To avoid image sticking, it is recommended to use a screen saver.
- (e) This Module has its circuitry PCB's on the rear side and should be handled carefully in order not to be stressed.
- (f) Please contact SEC in advance when you display the same pattern for a long time.